

Your Global Automation Partner

TURCK

TS720...

Temperature Processing and Display Unit

Instructions for Use

Contents

1	About these instructions	4
1.1	Target groups	4
1.2	Explanation of symbols used.....	4
1.3	Other documents	4
1.4	Feedback about these instructions	4
2	Notes on the product	5
2.1	Product identification	5
2.2	Scope of delivery.....	5
2.3	Turck service	5
3	For your safety	6
3.1	Intended use	6
3.2	Obvious misuse	6
3.3	General safety instructions	6
4	Product description	7
4.1	Device overview	7
4.2	Properties and features	7
4.3	Operating and display functions	7
4.4	Operating principle	7
4.5	Functions and operating modes	8
4.5.1	Setting options.....	8
4.5.2	Normal operation — run mode	8
4.5.3	Programming mode.....	8
4.5.4	Output functions — switching output.....	9
4.5.5	Output functions – analog output.....	10
4.5.6	IO-Link mode.....	12
4.5.7	SIO mode (standard I/O mode)	12
4.5.8	Auto detect function.....	12
4.6	Technical accessories	13
4.6.1	Connectivity accessories.....	13
4.6.2	Temperature probe	14
4.6.3	Compression fittings and thermowells	16
5	Installing	18
6	Connection	19
6.1	Wiring diagrams.....	20
6.2	Wiring diagrams – Temperature probes	21
6.3	Connection instructions for thermocouples	22
6.4	Connection instructions for resistance thermometers.....	22
7	Commissioning.....	23
8	Operation.....	24
8.1	LEDs — operation	24
8.2	Display indications	25
9	Setting and parameterization	26
9.1	Settable functions and properties.....	26
9.2	Setting via touchpads	27

- 9.2.1 Locking the device 31
- 9.2.2 Unlocking the device 31
- 9.2.3 Setting parameter values via touchpads 31
- 9.2.4 Protecting the sensor with a password 32
- 9.2.5 Parameters in the main menu 33
- 9.2.6 Parameters in the EF (Extended Functions) submenu 35
- 9.3 Setting via IO-Link 37
- 10 Troubleshooting 38
- 11 Maintenance 39
- 12 Repair 39
 - 12.1 Returning devices 39
- 13 Disposal 39
- 14 Technical data 40
- 15 Turck subsidiaries — contact information 42

1 About these instructions

These instructions for use describe the structure, functions and the use of the product and will help you to operate the product as intended. Read these instructions carefully before using the product. This is to avoid possible damage to persons, property or the device. Retain the instructions for future use during the service life of the product. If the product is passed on, pass on these instructions as well.

1.1 Target groups

These instructions are aimed at qualified personal and must be carefully read by anyone mounting, commissioning, operating, maintaining, dismantling or disposing of the device.

1.2 Explanation of symbols used

The following symbols are used in these instructions:



DANGER

DANGER indicates a dangerous situation with high risk of death or severe injury if not avoided.



WARNING

WARNING indicates a dangerous situation with medium risk of death or severe injury if not avoided.



CAUTION

CAUTION indicates a dangerous situation of medium risk which may result in minor or moderate injury if not avoided.



NOTICE

NOTICE indicates a situation which may lead to property damage if not avoided.



NOTE

NOTE indicates tips, recommendations and useful information on specific actions and facts. The notes simplify your work and help you to avoid additional work.



CALL TO ACTION

This symbol denotes actions that the user must carry out.



RESULTS OF ACTION

This symbol denotes relevant results of actions.

1.3 Other documents

Besides this document, the following material can be found on the Internet at www.turck.com:

- Data sheet
- Declarations of conformity
- Commissioning manual IO-Link devices

1.4 Feedback about these instructions

We make every effort to ensure that these instructions are as informative and as clear as possible. If you have any suggestions for improving the design or if some information is missing in the document, please send your suggestions to techdoc@turck.com.

2 Notes on the product

2.1 Product identification

These instructions apply to the following temperature processing and display units:

- TS720-2UPN8-H1141
- TS720-LI2UPN8-H1141

TS 7 2 0 - LI2UPN8 - H 1 1 4 1

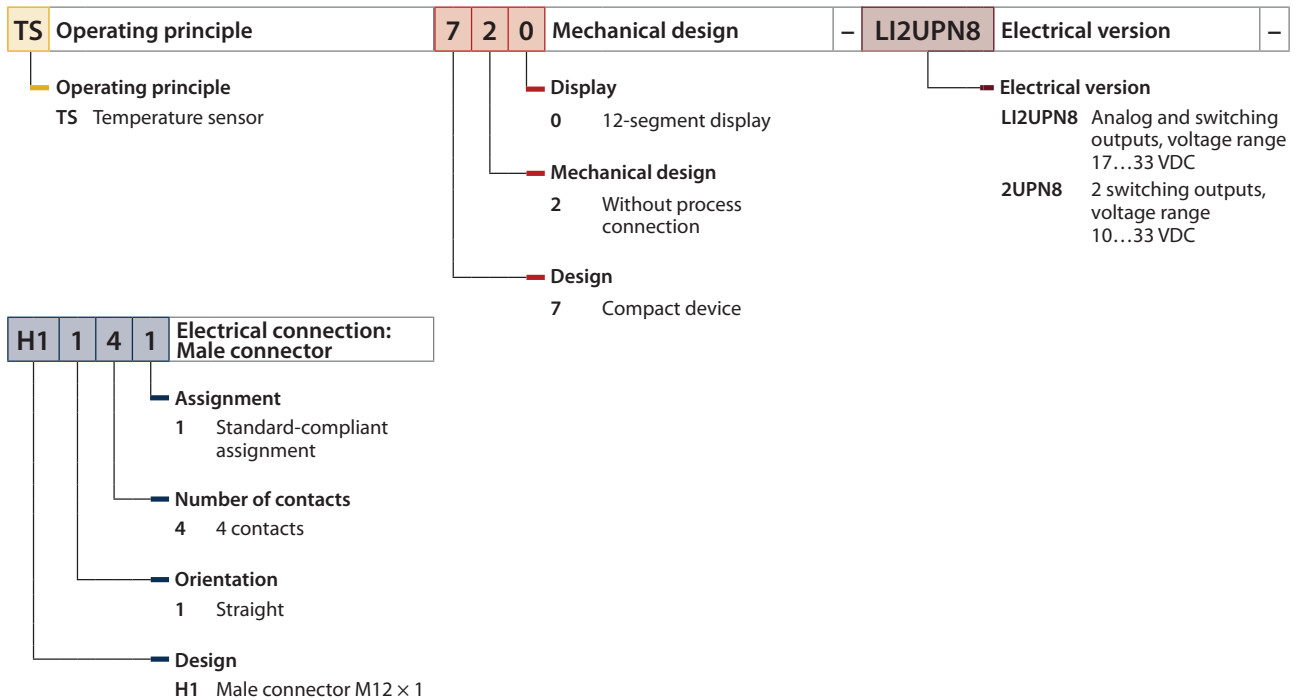

2.2 Scope of delivery

The scope of delivery includes:

- Temperature processing and display unit
- Quick Start Guide

2.3 Turck service

Turck supports you with your projects, from initial analysis to the commissioning of your application. The Turck product database under www.turck.com contains software tools for programming, configuration or commissioning, data sheets and CAD files in numerous export formats.

The contact details of Turck subsidiaries worldwide can be found on p. [▶ 42].

3 For your safety

The product is designed according to state-of-the-art technology. However, residual risks still exist. Observe the following warnings and safety notices to prevent damage to persons and property. Turck accepts no liability for damage caused by failure to observe these warning and safety notices.

3.1 Intended use

The compact processing and display units of the TS720... product series are designed for measuring temperatures in machines and plants. This requires the connection of a temperature probe to the devices. The temperature processing and display units support the connection of resistance thermometers (RTD) and thermocouples (TC).

The devices may only be used as described in these instructions. Any other use is not in accordance with the intended use. Turck accepts no liability for any resulting damage.

3.2 Obvious misuse

- The devices are not safety components and must not be used for personal or property protection.

3.3 General safety instructions

- The device meets the EMC requirements for industrial areas. When used in residential areas, take measures to avoid radio interference.
- The device may only be assembled, installed, operated, parameterized and maintained by professionally-trained personnel.
- The device may only be used in accordance with applicable national and international regulations, standards and laws.
- Only operate the device within the limits stated in the technical specifications.

4 Product description

The temperature processing and display units of the TS+ series are contained in a metal housing and provided with a G1/2" process connection. The sensor head can also be rotated by 340° after installation. The devices have a metal M12 connector (male) for connecting the sensor cable. Another M12 connector (female) is provided for connecting resistance thermometers (RTD) and thermocouples (TC).

Devices with the following output functions are available:

- TS...LI2UPN...: 2 switching outputs (PNP/NPN/Auto) or 1 switching output (PNP/NPN/Auto) and 1 analog output (I/U/Auto)
- TS...2UPN...: 2 switching outputs (PNP/NPN/Auto)

4.1 Device overview

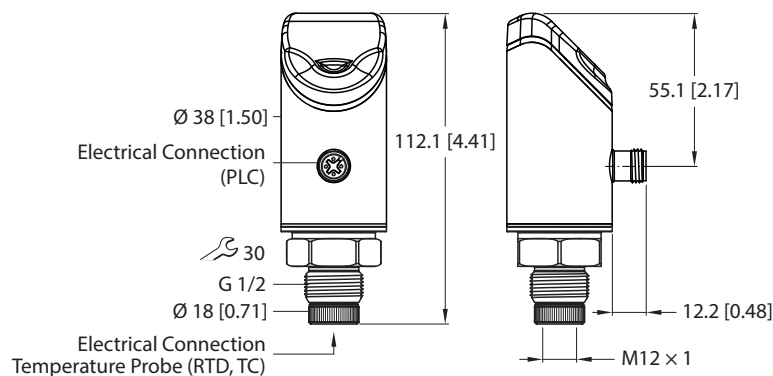

Fig. 1: Dimensions in mm [inch]

4.2 Properties and features

- Processing unit for connecting resistance thermometers (RTD) and thermocouples (TC)
- Automatic probe detection
- 4-digit, 2-colored, 12-segment display, rotatable by 180°
- Upper part of housing can be rotated up to 340°
- Various IO-Link mapping profiles selectable

4.3 Operating and display functions

The front of the device is provided with three touchpads [ENTER], [MODE] and [SET], a 4-digit 12-segment multicolor display and status LEDs. This enables the user to set all essential functions and properties directly on the device and read the actual process values and set switching points.

4.4 Operating principle

Standard Pt100 and Pt1000 resistance thermometers (RTD) as well as thermocouples (TC) can be connected to the temperature display and processing unit. The temperature value measured on the attached probe is passed on to the higher-level I/O. The device display shows the temperature value in the unit selected by the user.

4.5 Functions and operating modes

Type	Output
TS...LI2UPN...	2 switching outputs (PNP/NPN/Auto) or 1 switching output (PNP/NPN/Auto) and 1 analog output (I/U/Auto)
TS...2UPN...	2 switching outputs (PNP/NPN/Auto)

A window function or a hysteresis function can be set for the switching outputs. The measuring range of the analog output can be defined as required. The measured temperature can be displayed in °C, °F or K, or the resistance can be displayed in Ω if a resistance thermometer is connected. The devices can be parameterized via IO-Link and via touchpads. The following temperature probes can be connected to the device:

- Resistance thermometers (RTD)
 - Pt100 (2-, 3-, 4-wire)
 - Pt1000 (2-, 3-, 4-wire)
- Thermocouples (TC)
 - Type K, B, E, J, N, R, S and T

4.5.1 Setting options

The devices have three setting options:

- Setting via IO-Link
- Setting via touchpads
- Setting via FDT/DTM

4.5.2 Normal operation — run mode

The device detects the temperature on the probe and shows the required switching or analog behavior according to the factory-set or customer-specific parameters. The display indicates the process temperature present, the selected unit and the status of the switching outputs.

4.5.3 Programming mode

When the sensor is unlocked, the display will go into programming mode after the user presses the [MODE] touch pad. In programming mode, all parameters and their corresponding values can be read out and changed. The values for a parameter are displayed by briefly pressing the [ENTER] touch pad. The [MODE] and [SET] touch pads are used to navigate within programming mode. For more information, refer to the chapter "Setting and parameterization."

4.5.4 Output functions — switching output

A window function and a hysteresis function can be set for the switching outputs.

Window function

The window function is used to set a switching range in which the switching output takes on a defined switching state. The switching range is defined by means of an upper (FH) and lower limit (FL). The minimum distance between the limits is 0.2 K. If the upper limit is changed, the lower limit value is adjusted automatically.

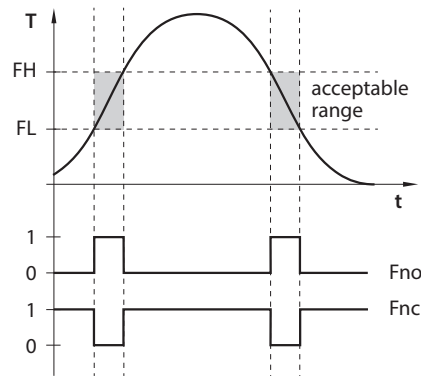

Fig. 2: Behavior of the switching output – Window function

Hysteresis function

The hysteresis function is used to set a stable switching state around a setpoint that is independent of system-related temperature fluctuations. The switching range is defined by means of a switching point (SP) and a release point (rP). The minimum hysteresis is 0.2 K. If the switching point is changed, the release point is adjusted automatically.

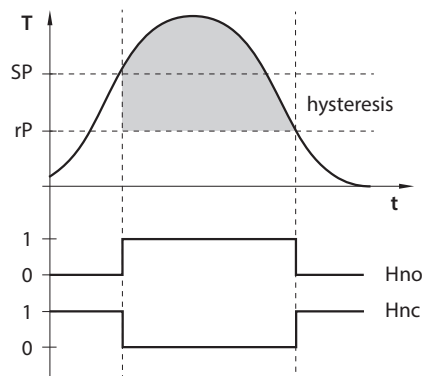

Fig. 3: Behavior of the switching output (hysteresis function)

4.5.5 Output functions – analog output

The minimum distance between the start and end point is 0.2 K.

The analog output of the TS720...LI2UPN8 devices can be set as either a current or voltage output. The output range is freely scalable to the measuring range.

Current output

In the defined measuring range, the device supplies an analog current signal between ASP (analog start point) and AEP (analog end point). The following output configurations can be set:

- 4...20 mA (factory setting)
- 0...20 mA
- 20...4 mA
- 20...0 mA

Voltage output

In the defined measuring range, the device supplies an analog voltage signal between ASP (analog start point) and AEP (analog end point). The following output configurations can be set:

- 0...10 V
- 0...5 V
- 1...6 V
- 0.5...4.5 V (rtio)
- 10...0 V
- 5...0 V
- 6...1 V

Output behavior of the analog outputs

The following figures illustrate the behavior of the analog outputs:

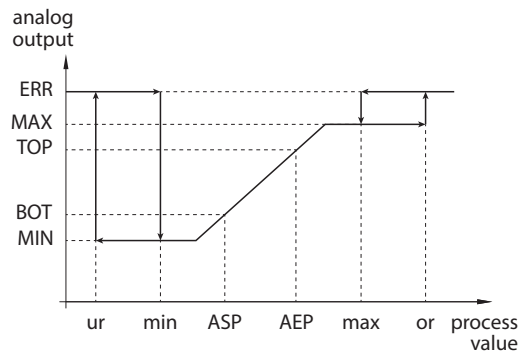

Fig. 4: Rising output characteristic

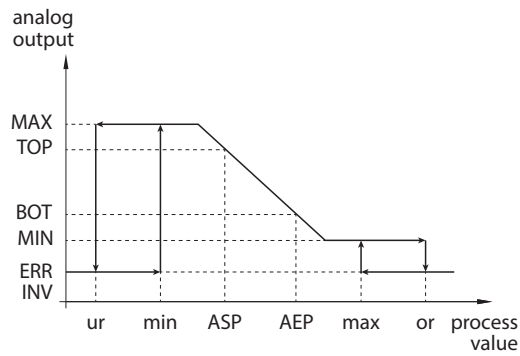

Fig. 5: Falling output characteristic, MIN \neq 0

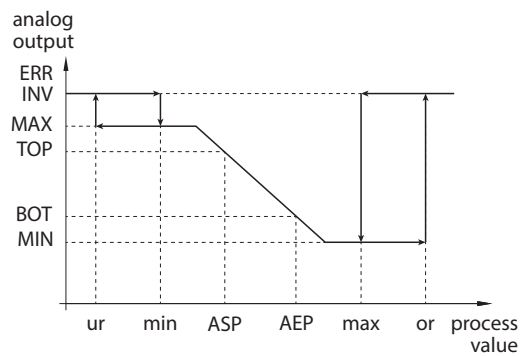

Fig. 6: Falling output characteristic, MIN = 0

Output configuration		BOT	TOP	ERR INV	MIN	MAX	ERR
4...20 mA	20...4 mA	4 mA	20 mA	3.5 mA	3.8 mA	20.5 mA	21.1 mA
0...20 mA	20...0 mA	0 mA	20 mA	21.1 mA	0 mA	20.5 mA	21.1 mA
0...10 V	10...0 V	0 V	10 V	11 V	0 V	10.5 V	11 V
0...5 V	5...0 V	0 V	5 V	6 V	0 V	5.5 V	6 V
1...6 V	6...1 V	1 V	6 V	0 V	0.5 V	6.5 V	7 V
0.5...4.5 V	4.5...0.5 V	0.5 V	4.5 V	5.5 V	0 V	5 V	5.5 V

Abbreviation	Description
ERR	Fault value
MAX	Upper value of the analog output
MIN	Lower value of the analog output
ASP	Analog start point
AEP	Analog end point
TOP	Value of the output when the AEP is reached
BOT	Value of the output when the ASP is reached
ur	Underrun/underrange
or	Overrun/overrange
max	Maximum process value
min	Minimum process value

4.5.6 IO-Link mode

In order to operate in IO-Link mode, the device must be connected to an IO-Link master. When the port is configured in IO-Link mode, bidirectional IO-Link communication takes place between the IO-Link master and the device. To make this possible, the device is integrated via an IO-Link master at the control level. First the communication parameters are exchanged, and then the cyclic data exchange of process data (objects) starts.

4.5.7 SIO mode (standard I/O mode)

In standard I/O mode no IO-Link communication takes place between the device and the master. The device only transfers the switching state of its binary outputs and can also be run via a fieldbus device or controller with digital PNP or NPN inputs. An IO-Link master is not required for operation.

The device parameters can be set via IO-Link and then operated at the digital inputs with the appropriate settings in SIO mode. Not all functions and properties of the device can be used in SIO mode.



4.5.8 Auto detect function

The device uses the auto detect function to detect whether a resistance thermometer or a thermocouple is connected. The type of thermocouple is determined by the user. When connected to an I/O module, the device detects the pre-defined switching output behavior (PNP/NPN) or the analog output characteristic. The auto detect function is activated by default.

4.6 Technical accessories

4.6.1 Connectivity accessories

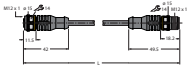
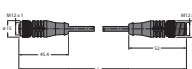
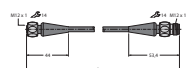
In addition to the below listed connection cables, Turck also offers other cable types for specific applications with the correct terminals for the device. More information on this is available from the Turck product database at www.turck.de/products in the Connectivity area.

Dimension drawing	Type	ID	Description
	RKC4.4T-2-RSC4.4T/TEL	6625208	Extension cable, M12 female to male, straight, 4-pin, cable length: 2 m, jacket material: PVC, black; cULus approval
	RKC4.4T-2-RSC4.4T/TXL	6625608	Extension cable, M12 female, straight, 4-pin to M12 male, straight, 4-pin; cable length: 2 m, jacket material: PUR, black; cuLus approval
	HT-WAK4-2-HT-WAS4/S2430	8038668	High-temperature-resistant extension cable, M12 female, straight, 4-pin to M12 male, straight, 4-pin; cable length: 2 m, jacket material: PTFE, white
	RKH4.4-2-RSH4.4/TFG	6933472	Food and Beverage extension cable, M12 female, straight, 4-pin to M12 male, straight, 4-pin; cable length: 2 m, jacket material: TPE, gray; approval: Ecolab, FDA
	RK4.217T-...-RS4.217T/TS7198	100033104	Type K thermocouple cable, extension cable, M12 coupling, straight, 2-pole; cable length: 2 m, jacket material: TPE, green
		100033105	Type K thermocouple cable, extension cable, M12 coupling, straight, 2-pole; cable length: 5 m, jacket material: TPE, green
		100033107	Type K thermocouple cable, extension cable, M12 coupling, straight, 2-pole; cable length: 7 m, jacket material: TPE, green

4.6.2 Temperature probe



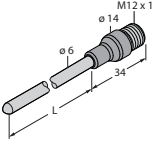
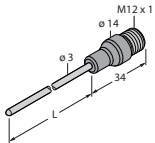
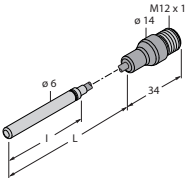
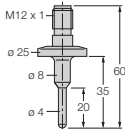

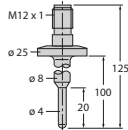
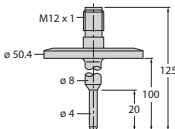
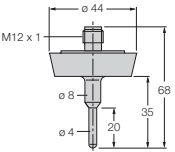
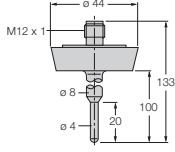
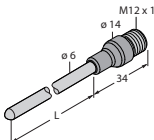

The temperature probes are connected to the temperature processing and display units via M12 connectors. The temperature probes shown offer a selection of the versions. For more versions, visit <https://www.turck.de/en/productgroup/> and view the selection of temperature sensors and accessories.

Dimension drawing	Type	ID	Description
	TP-206A-CF-H1141-L100	9910475	Temperature probe for liquid and gaseous media, Pt100, class A; measuring range -50...500 °C; dimensions Ø 6 × 100 mm
	TP-206A-CF-H1141-L150	9910476	Temperature probe for liquid and gaseous media, Pt100, class A; measuring range -50...500 °C; dimensions Ø 6 × 150 mm
	TP-206A-CF-H1141-L200	9910477	Temperature probe for liquid and gaseous media, Pt100, class A; measuring range -50...500 °C; dimensions Ø 6 × 200 mm
	TP-206A-CF-H1141-L300	9910478	Temperature probe for liquid and gaseous media, Pt100, class A; measuring range -50...500 °C; dimensions Ø 6 × 300 mm
	TP-203A-CF-H1141-L100	9910402	Temperature probe for liquid and gaseous media, Pt100, class A; measuring range -50...500 °C; dimensions Ø 3 × 100 mm
	TP-203A-CF-H1141-L150	9910403	Temperature probe for liquid and gaseous media, Pt100, class A; measuring range -50...500 °C; dimensions Ø 3 × 150 mm
	TP-203A-CF-H1141-L200	9910482	Temperature probe for liquid and gaseous media, Pt100, class A; measuring range -50...500 °C; dimensions Ø 3 × 200 mm
	TP-203A-CF-H1141-L300	9910474	Temperature probe for liquid and gaseous media, Pt100, class A; measuring range -50...500 °C; dimensions Ø 3 × 300 mm
	TP-306A-CF-H1141-L1000	9910479	Temperature probe for liquid and gaseous media, Pt100, class A; measuring range -50...105 °C; dimensions Ø 6 × 50 mm; with connection cable, length 1000 mm
	TP-306A-CF-H1141-L2000	9910480	Temperature probe for liquid and gaseous media, Pt100, class A; measuring range -50...105 °C; dimensions Ø 6 × 50 mm; connection cable, length 2000 mm
	TP-306A-CF-H1141-L5000	9910481	Temperature probe for liquid and gaseous media, Pt100, class A; measuring range -50...105 °C; dimensions Ø 6 × 50 mm; connection cable, length 5000 mm
	TP-504A-TRI3/4-H1141-L035	9910429	Temperature probe for liquid and gaseous media, Pt100, class A; measuring range -50...125 °C; installation length 35 mm; process connection Tri-Clamp 3/4"

Dimension drawing	Type	ID	Description
	TP-504A-TRI3/4-H1141-L100	9910430	Temperature probe for liquid and gaseous media, Pt100, class A; measuring range -50...125 °C; installation length 100 mm; process connection Tri-Clamp 3/4"
	TP-504A-TRI1.5-H1141-L100	9910860	Temperature probe for liquid and gaseous media, Pt100, class A; measuring range -50...125 °C; installation length 100 mm; process connection Tri-Clamp 1 1/2"
	TP-504A-DN25K-H1141-L035	9910431	Temperature probe for liquid and gaseous media, Pt100, class A; measuring range -50...125 °C; installation length 35 mm; process connection DN25 according to DIN 11851
	TP-504A-DN25K-H1141-L100	9910432	Temperature probe for liquid and gaseous media, Pt100, class A; measuring range -50...125 °C; installation length 100 mm; process connection DN25 according to DIN 11851
	TP-206KK1-CF-H1141-L100	100017085	Temperature probe for liquid and gaseous media, type K thermocouple, class 1; measuring range -40...1100 °C; dimensions Ø 6 × 100 mm
	TP-206KK1-CF-H1141-L150	100017084	Temperature probe for liquid and gaseous media, type K thermocouple, class 1; measuring range -40...1100 °C; dimensions Ø 6 × 150 mm
	TP-206KK1-CF-H1141-L200	100017083	Temperature probe for liquid and gaseous media, type K thermocouple, class 1; measuring range -40...1100 °C; dimensions Ø 6 × 200 mm
	TP-206KK1-CF-H1141-L500	100017082	Temperature probe for liquid and gaseous media, type K thermocouple, class 1; measuring range -40...1100 °C; dimensions Ø 6 × 500 mm

4.6.3 Compression fittings and thermowells

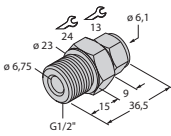
The temperature probe is introduced into the process by means of compression fittings or thermowells. The compression fittings and thermowells shown offer a selection of the versions. For more versions, visit <https://www.turck.de/en/productgroup/> and view the selection of temperature sensors and accessories.

Dimension drawing	Type	ID	Description
	CF-M-3-G1/8-A4	9910405	Compression fitting for direct mounting of temperature probes; probe diameter 3 mm; process connection G1/8" male thread
	CF-M-3-N1/8-A4	9910406	Compression fitting for direct mounting of temperature probes; probe diameter 3 mm; process connection 1/8" NPT male thread
	CF-M-3-N1/4-A4	9910408	Compression fitting for direct mounting of temperature probes; probe diameter 3 mm; process connection 1/4" NPT male thread
	CF-M-3-G1/4-A4	9910407	Compression fitting for direct mounting of temperature probes; probe diameter 3 mm; process connection G1/4" male thread
	CF-M-6-G1/4-A4	9910483	Compression fitting for direct mounting of temperature probes; probe diameter 6 mm; process connection G1/4" male thread
	CF-M-6-G1/2-A4	9910530	Compression fitting for direct mounting of temperature probes; probe diameter 6 mm; process connection G1/2" male thread
	CF-M-6-N1/4-A4	9910484	Compression fitting for direct mounting of temperature probes; probe diameter 6 mm; process connection 1/4" NPT male thread

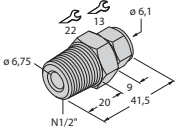
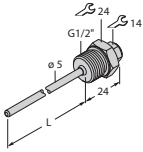
Dimension drawing	Type	ID	Description
	CF-M-6-N1/2-A4	9910529	Compression fitting for direct mounting of temperature probes; probe diameter 6 mm; process connection 1/2" NPT male thread
	THW-3-G1/2-A4-L050	9910443	Thermowell for mounting temperature probes; probe diameter 3 mm; process connection G1/2" external thread; immersion depth 50 mm
	THW-3-G1/2-A4-L100	9910444	Thermowell for mounting temperature probes; probe diameter 3 mm; process connection G1/2" male thread; insertion depth 100 mm
	THW-3-G1/2-A4-L200	9910487	Thermowell for mounting temperature probes; probe diameter 3 mm; process connection G1/2" external thread; immersion depth 200 mm
	THW-3-G1/2-A4-L250	9910446	Thermowell for mounting temperature probes; probe diameter 3 mm; process connection G1/2" external thread; immersion depth 250 mm

5 Installing

The temperature processing and display unit features a G1/2" thread (SW30) for mounting with an application-specific mounting bracket. Alternatively, the device can be mounted with the FAM-30-PA66 (ID 100018384) mounting bracket. The display of the unit can be rotated by 180° (see figure and parameter DiSr).

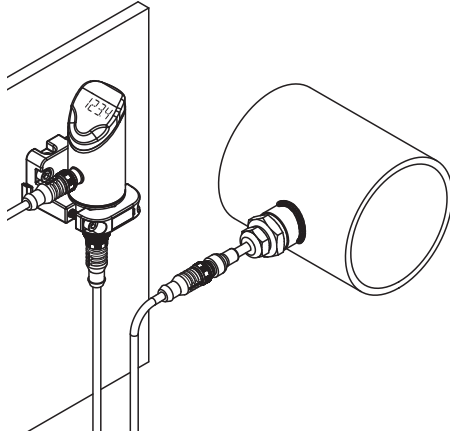

Fig. 7: Installing TS720...

- ▶ Mount the temperature processing and display unit on any part of the plant. Observe the technical specifications for mounting (e.g. ambient temperature).
- ▶ Optional: Rotate the sensor head within the 340° range to align the connection to the I/O level as well as to ensure optimum operability and readability.

6 Connection



NOTE

For USA/Canada: The devices must be supplied with limited energy in accordance with UL 61010-1 3rd Edition, section 9.4 or LPS in accordance with UL 60950-1 or Class 2 in accordance with UL 1310 or UL 1585. Connect the sensor to a separated extra-low voltage (SELV) power supply.

The connection cables between the temperature probe and the compact processing and display unit must have a rated operating temperature of at least 75 °C and a rated voltage of at least 300 V RMS.

Standard 2-, 3- and 4-wire Pt100 and Pt1000 resistance thermometers (RTD) as well as thermocouples (TC) of types K, B, E, J, N, R, S and T can be connected to the temperature processing and display unit.

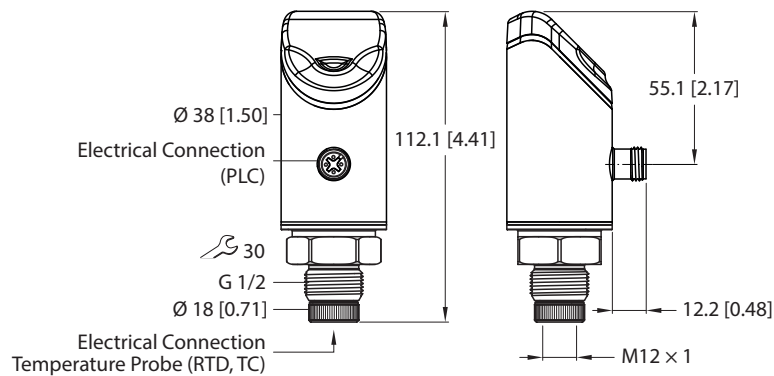

Fig. 8: Electrical connections for controller and temperature probe

- ▶ Connect the temperature probe to the temperature processing and display unit in accordance with the relevant specifications (see "Electrical connection for temperature probes (RTD, TC)"). Observe here the technical specifications and the installation instructions of the temperature probe.
- ▶ Connect the device to the controller or an I/O module according to the wiring diagram (see "Electrical connection").

6.1 Wiring diagrams

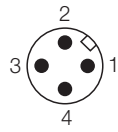

Fig. 9: Pin assignment TS...LI2UPN...

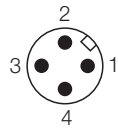

Fig. 11: Pin assignment TS...2UPN...

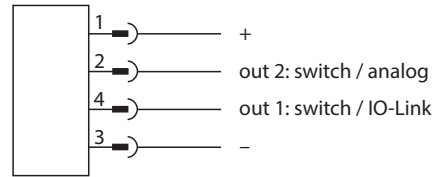

Fig. 10: Wiring diagram TS...2LIUPN...

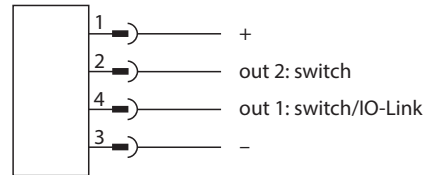

Fig. 12: Wiring diagram TS...2UPN...

6.2 Wiring diagrams – Temperature probes

Resistance thermometer (RTD) — 2-wire

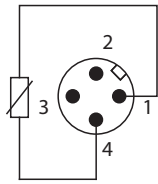

Fig. 13: RTD, 2-wire

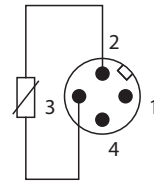

Fig. 14: RTD, 2-wire

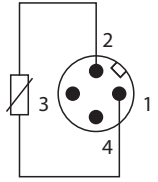

Fig. 15: RTD, 2-wire

Resistance thermometer (RTD) — 3-wire

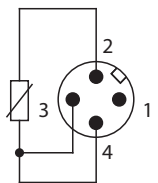

Fig. 16: RTD, 3-wire

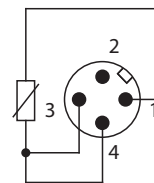

Fig. 17: RTD, 3-wire

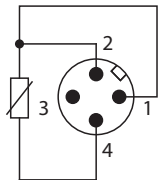

Fig. 18: RTD, 3-wire

Resistance thermometer (RTD) — 4-wire

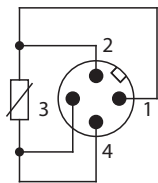

Fig. 19: RTD, 4-wire

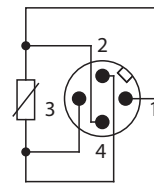

Fig. 20: RTD, 4-wire

Thermocouples (TC)

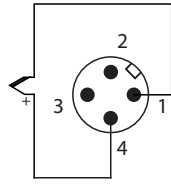

Fig. 21: Thermocouple between Pin 1 and Pin 4

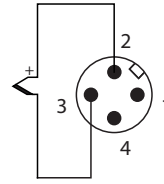

Fig. 22: Thermocouple between Pin 2 and Pin 3

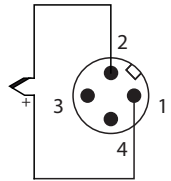

Fig. 23: Thermocouple between Pin 1 and Pin 2

6.3 Connection instructions for thermocouples

- ▶ Observe the following instructions when connecting thermocouples:
 - Use thermocouples and cables in accordance with IEC 60584.
 - Turck recommends the use of compensated connectors and connection cables. If thermocouples are connected with incorrect balancing lines or copper lines, the device may output an implausible reading.
 - Use shielded cables for connection and connect the shield to one side.
 - Automatic detection (factory setting) is designed for thermocouples with a 4-pin M12 connector. When using thermocouples with a 4-pin M12 connection and corresponding extension or balancing cable, Turck recommends using automatic detection of the probe configuration. The thermocouple type must also be selected.
 - A Pt1000 resistor is used as an internal reference point. It is not possible to use an external reference point.

6.4 Connection instructions for resistance thermometers

- ▶ Observe the following instructions when connecting resistance thermometers:
 - Keep the cable length as short as possible for a 2-wire circuit.
 - Do not change the circuit types by adding additional bridges to the connector.

7 Commissioning

The device is operational automatically once the power supply is switched on.

The device uses the auto detect function to detect whether a resistance thermometer or a thermocouple is connected. The type of thermocouple is determined by the user. When connected to an I/O module, the device detects the pre-defined switching output behavior (PNP/NPN) or the analog output characteristic. The auto detect function is activated by default.

8 Operation



WARNING

The enclosure can heat to over 75 °C (167 °F).

Risk of burns from hot enclosure surfaces!

- ▶ Prevent the enclosure from coming into contact with flammable substances.
- ▶ Prevent the enclosure from being touched unintentionally.

8.1 LEDs — operation

LED	Display	Meaning
PWR	Green	Device is operational
	Green flashing	IO-Link communication
FLT	Red	Error
°C	Green	Temperature in °C
°F	Green	Temperature in °F
K	Green	Temperature in K
Ω	Green	Resistance in Ω (resistance thermometers only)
LOC	Yellow	Device locked
	Yellow flashing	“Lock/unlock” process active
	Off	Device unlocked
I and II (switching point LEDs)	Yellow	Switching output <ul style="list-style-type: none"> ■ NO: Switching point exceeded/within window (active output) ■ NC: Switching point undershot/outside window (active output)
	Off	Switching output <ul style="list-style-type: none"> ■ NO: Switching point undershot/outside window (inactive output) ■ NC: Switching point exceeded/within window (inactive output)

8.2 Display indications

Display	Meaning
Flashing	Value outside the measuring range, temperature > 5 % of full scale above or below the measuring range
Unit flashes red	Display unit set to Ω , but thermocouple connected
OL	Value outside the measuring range, temperature > 5 % of full scale above the measuring range
UL	Value outside the measuring range, temperature > 5 % of full scale below the measuring range
SC1	Short circuit at output 1
SC 2	Short circuit at output 2
SC12	Short circuit at both outputs
Wb 2	Wire break at current output 2
ErrH	Internal hardware error
ErrF	Faulty factory parameters
ErrC	Internal communication fault or malfunction
ErrP	Probe not present, incorrectly connected or faulty
ErrU	Operating voltage outside the permissible range
ErrL	Load on the analog output outside the permissible range
ErrT	Device temperature outside the permissible range
Loc	Device locked
uLoc	Device unlocked
----	Sensor failure

9 Setting and parameterization

The device can be parameterized as follows:

- Setting via touchpad
- Setting via IO-Link
- Setting via FDT/DTM

9.1 Settable functions and properties

The three front touchpads [ENTER], [MODE] and [SET] enable the user to set all the essential functions and properties directly on the device via the menu guidance. It is also possible to configure the device via the IO-Link interface (see IO-Linkfinder).

Setting options — via touchpads and IO-Link interface

The following functions and properties can be set and used both in standard I/O mode as well as in IO-Link mode:

- Locking/unlocking the device
- Window function
- Hysteresis function
- Analog range
- Probe configuration
- Thermocouple type
- OUT1 output configuration for SIO mode: PNP/NPN, automatic detection on/off
- OUT2 output configuration for SIO mode: PNP/NPN, automatic detection on/off
- Advanced settings: Reset to factory settings
- Advanced settings: Minimum and maximum value memory
- Advanced settings: Offset adjustment
- Advanced settings: Display color and behavior

Other setting options — only via touchpads

- Advanced settings: Reset to the previous settings (Pre-Settings)
- Advanced settings: Password setting

Other setting options — only via IO-Link

Additional functions and properties can also be set via the IO-Link interface.

- Setting display units for IO-Link mode (metric, imperial)
- Fully lock user interface (display and touchpads locked)
- Lock local parameters (user interface parameters — parameters are displayed but cannot be changed)

Auto detect function

The device uses the auto detect function to detect whether a resistance thermometer or a thermocouple is connected. The type of thermocouple is determined by the user. When connected to an I/O module, the device detects the pre-defined switching output behavior (PNP/NPN) or the analog output characteristic. The auto detect function is activated by default.

9.2 Setting via touchpads

Use the [MODE] or [SET] touchpads to navigate through the main menu and the EF extended functions menu. A Turck-specific default menu guidance as well as a VDMA menu can be selected. The menu guidance can be set via the SoF parameter.

Standard menu guidance — main menu

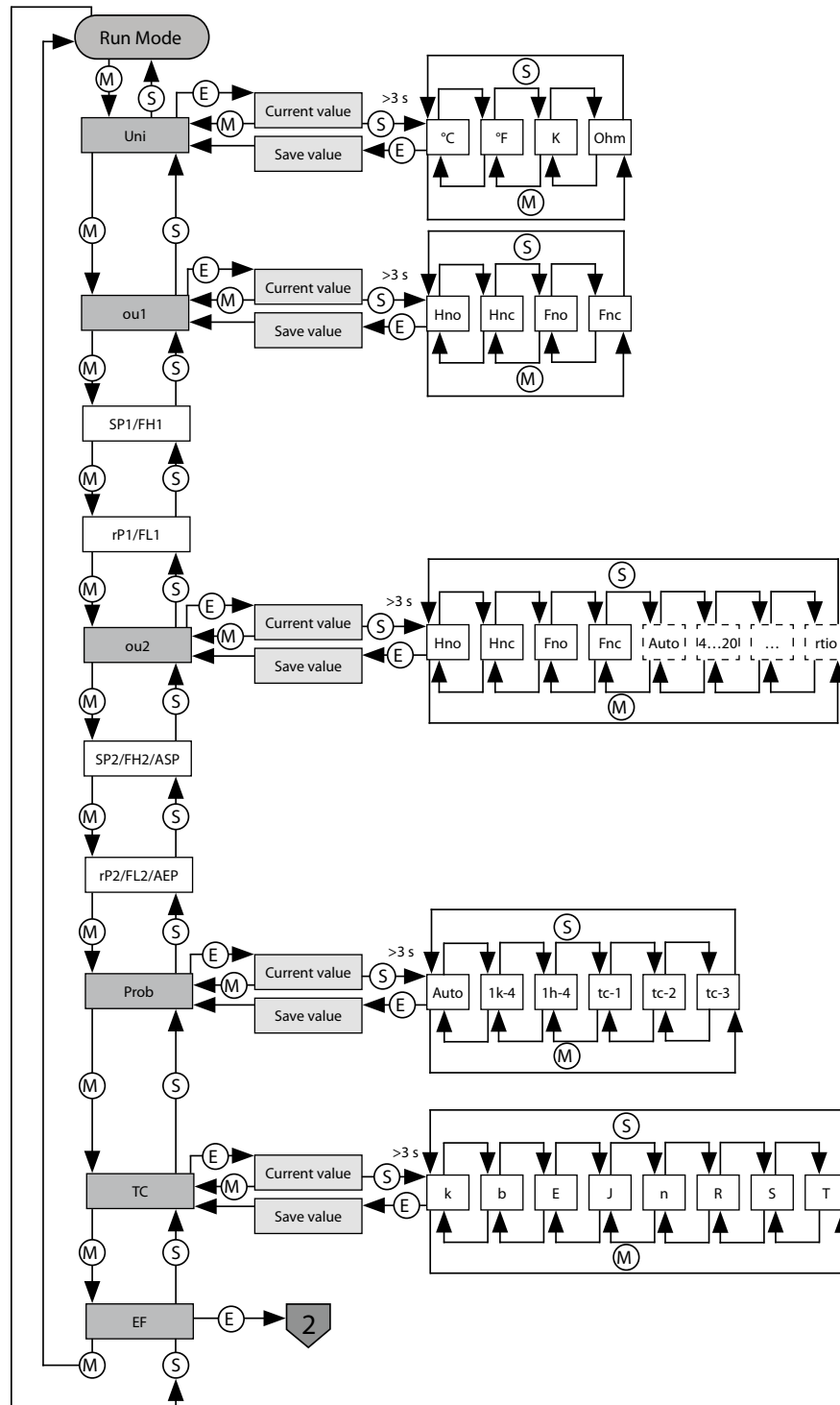

Fig. 24: Standard menu guidance — main menu

Standard menu guidance — EF extended functions menu

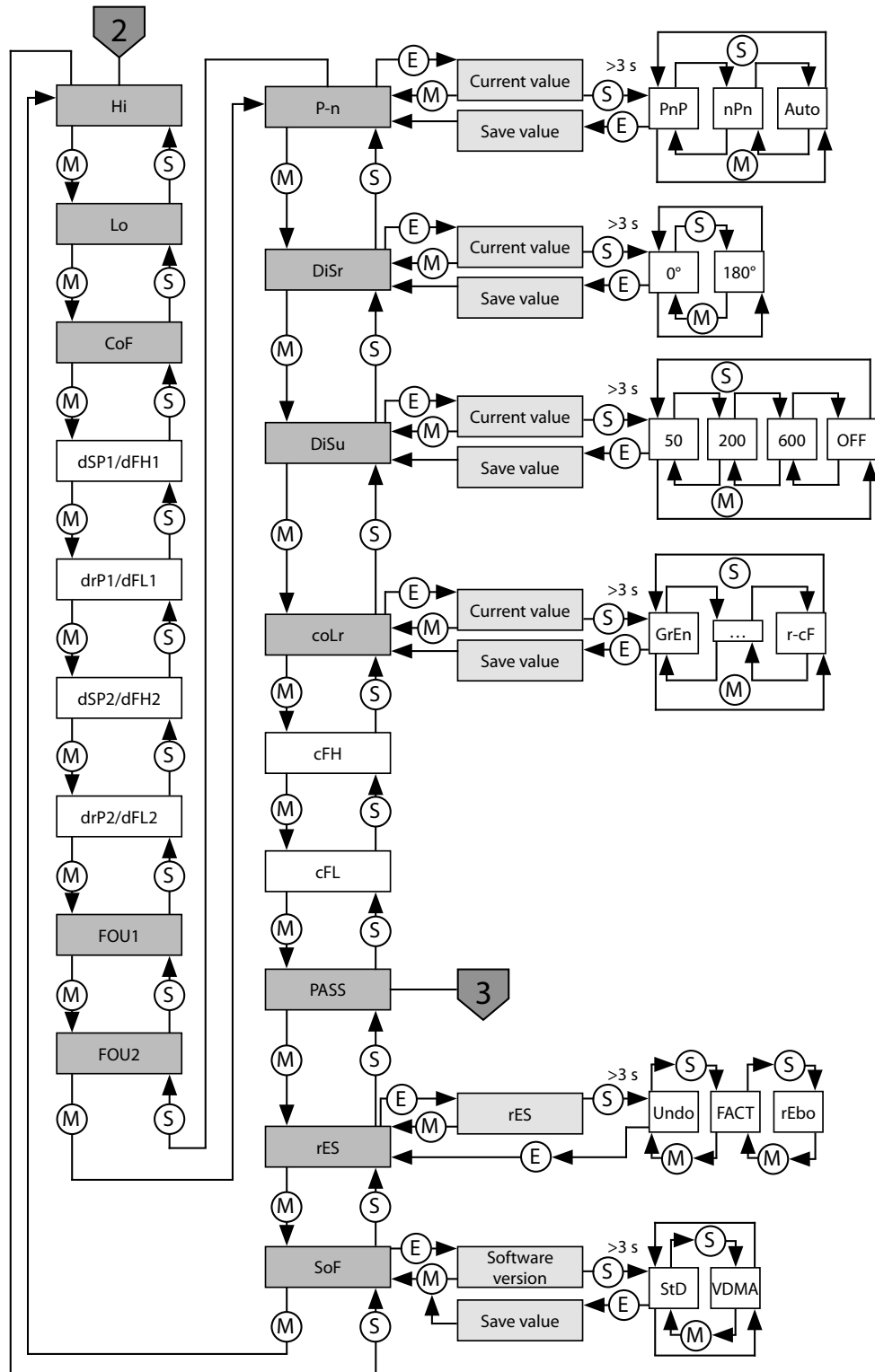

Fig. 25: Standard menu guidance — EF extended functions menu

VDMA menu — main menu

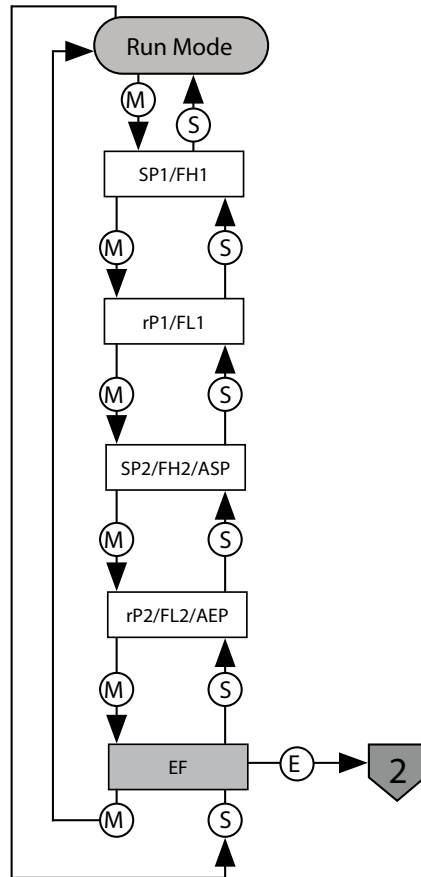

Fig. 26: VDMA menu — main menu

VDMA menu — EF extended functions menu

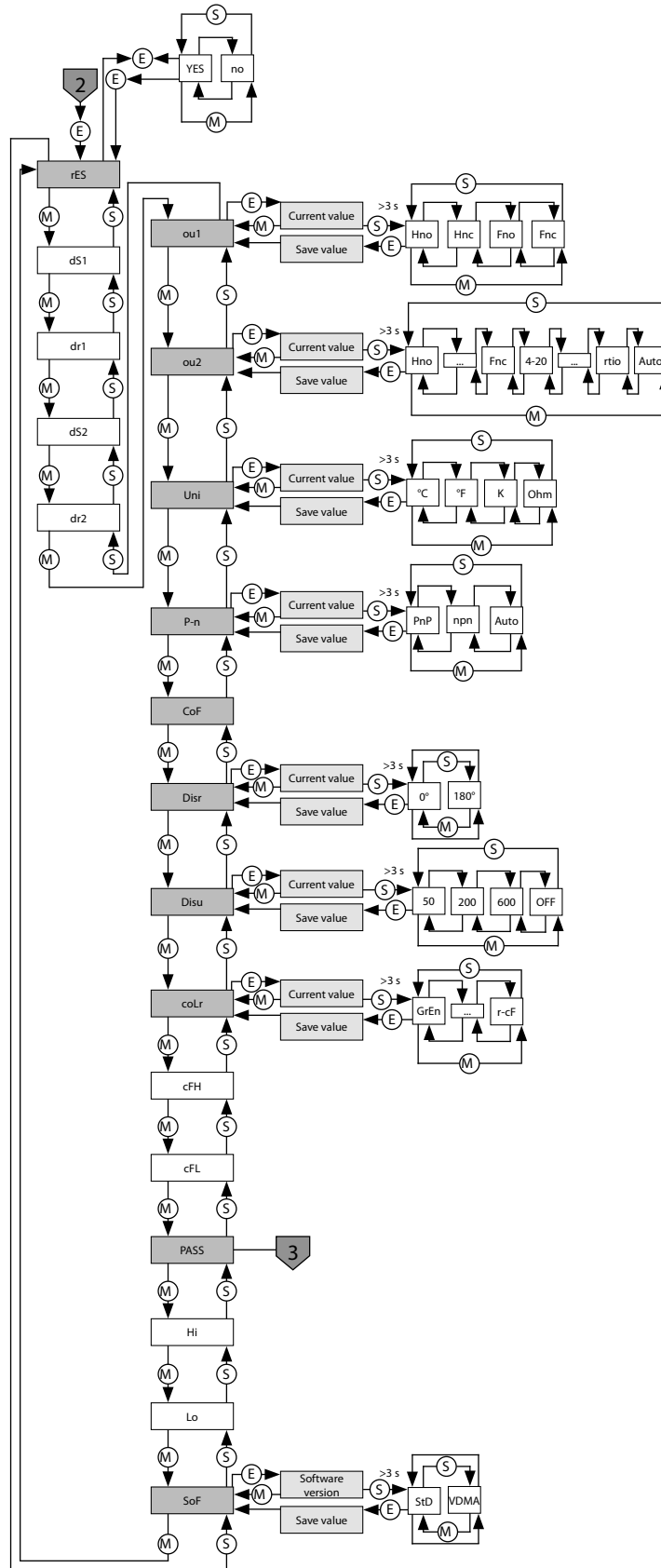

Fig. 27: VDMA menu — EF extended functions menu

9.2.1 Locking the device

- ▶ Touch [MODE] and [SET] simultaneously for 3 s.
- ⇒ When the LOC LED flashes, Loc will appear on the display and then go out.
- ⇒ LOC LED is yellow.

The sensor is automatically locked if the touchpads of the device are not actuated for 1 min.

9.2.2 Unlocking the device

- ▶ Touch [ENTER] for 3 s until all green bars are flashing on the display.
- ▶ Swipe [MODE], [ENTER], [SET] in succession: Two red flashing bars appear when each touchpad is touched. Once the two red bars have turned green, move onto the next touchpad without removing your finger from the touchscreen.
- ▶ Release the touchpads when six green bars are flashing on the display.
- ⇒ LOC LED goes off.
- ⇒ uLoc appears in the display and then disappears.

9.2.3 Setting parameter values via touchpads

Turck standard menu

- ▶ Unlock the device when [MODE] or [SET] is touched, a red running light appears and the LOC LED is lit.
- ▶ Touch [MODE] or [SET] until the required parameter is displayed.
- ▶ Touch [ENTER] to select a parameter.
- ▶ Changing the displayed value: Touch [SET] for 3 s until the display is no longer flashing. Or: Touch [MODE] in order to return to parameter selection.
- ▶ Increase or decrease the value incrementally via [MODE] or [SET]. Certain values can be changed by continuously touching [MODE] or [SET].
- ▶ Touch [ENTER] to save the modified value. The saved value flashes twice.

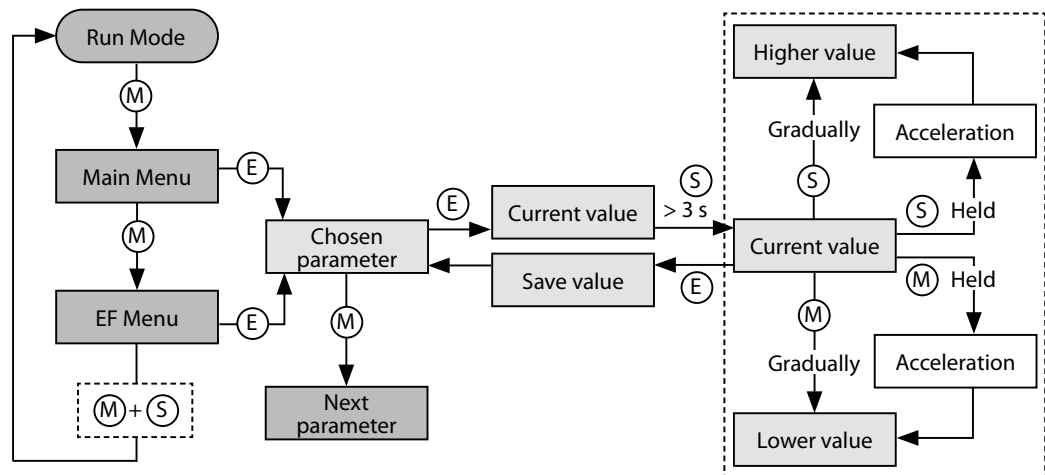

Fig. 28: Setting parameter values

VDMA menu

- ▶ Unlock the device when [MODE] or [SET] is touched, a red running light appears and the LOC LED is lit.
- ▶ Touch [MODE] or [SET] until the required parameter is displayed.
- ▶ Touch [ENTER] to select a parameter.
- ▶ Increase or decrease the value incrementally via [MODE] or [SET]. Certain values can be changed by continuously touching [MODE] or [SET].
- ▶ Touch [ENTER] to save the modified value. The saved value flashes twice.

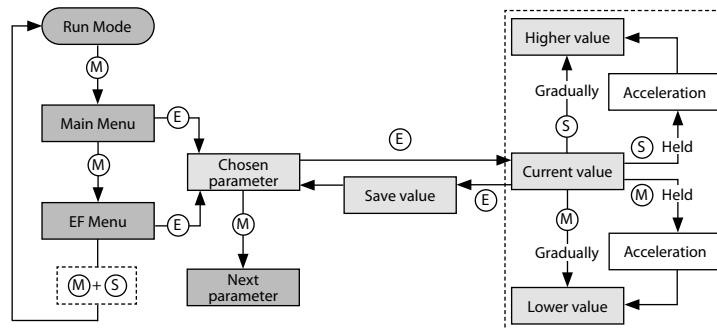

Fig. 29: Setting parameter values

9.2.4 Protecting the sensor with a password

- ▶ Select PASS in the EF menu.
- ▶ Change the values via the [SET] touchpad.
- ▶ Use [MODE] to navigate between the four digits of the password.
- ▶ Use [ENTER] to store the new password.

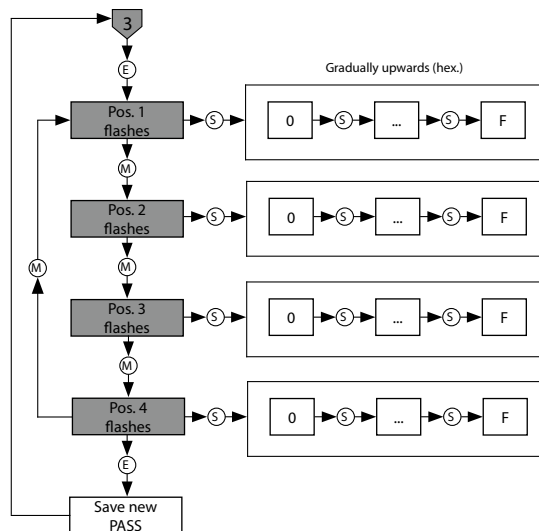

Fig. 30: Password setting

9.2.5 Parameters in the main menu

Default values are shown in **bold**.

	Explanation	Options	Function
Uni	Display unit	°C	°C
		°F	°F
		K	K
		Ω	Ohm
ou1	Function of output 1	Hno	Hysteresis function (NO = NO contact)
		Hnc	Hysteresis function (NC = NC contact)
		Fno	Window function (NO = NO contact)
		Fnc	Window function (NC = NC contact)
SP1	Switching point 1 for hysteresis function ou1: Hno/Hnc		Upper limit value at which output 1 changes its switching state as the temperature rises Default: 80.0 °C
rP1	Release point 1 for hysteresis function ou1: Hno/Hnc		Lower limit value at which output 1 changes its switching state as the temperature falls Default: 70.0 °C
FH1	Upper switching point for window function ou1: Fno/Fnc		Upper switching point at which output 1 changes its switching state Default: 80.0 °C
FL1	Lower switching point for window function ou1: Fno/Fnc		Lower switching point at which output 1 changes its switching state Default: 70.0 °C
ou2	Function of output 2	Hno	Hysteresis function (NO = NO contact)
		Hnc	Hysteresis function (NC = NC contact)
		Fno	Window function (NO = NO contact)
		Fnc	Window function (NC = NC contact)
	Analog output	Auto	Automatic detection (4...20 mA/0...10 V)
		4-20	4...20 mA
		0-20	0...20 mA
		20-4	20...4 mA
		20-0	20...0 mA
		0-10	0...10 V
		0-5	0...5 V
		1-6	1...6 V
		10-0	10...0 V
		5-0	5...0 V
6-1	6...1 V		
rtio	0.5...4.5 V		
SP2	Switching point 2 ou2: Hno/Hnc		Upper limit value at which output 2 changes its switching state as the temperature rises Default: 80.0 °C
rP2	Release point 2 ou2: Hno/Hnc		Lower limit value at which output 2 changes its switching state as the temperature falls Default: 70.0 °C

	Explanation	Options	Function
FH2	Upper switching point for window function ou2: Fno/Fnc		Upper switching point at which output 2 changes its switching state Default: 80.0 °C
FL2	Lower switching point for window function ou2: Fno/Fnc		Lower switching point at which output 2 changes its switching state Default: 70.0 °C
ASP	Start point of the analog signal ou2: Auto/analog values/rtio		Temperature value at which the analog output signal has its start point Default: -49.8 °C
AEP	End point of the analog signal ou2: Auto/analog values/rtio		Temperature value at which the analog output signal has its end point Default: 50.0 °C
Prob	Probe configuration	Auto	Automatic detection of the temperature probe
		1k-4	4-wire Pt1000 probe (connected to Pin 1 Pin 2 and Pin 3 Pin 4)
		1h-4	4-wire Pt1000 probe (connected to Pin 1 Pin 2 and Pin 3 Pin 4)
		tc-1	Thermocouple between Pin 1 and Pin 4
		tc-2	Thermocouple between Pin 2 and Pin 3
		tc-3	Dual thermocouple between Pin 1 and Pin 4, and Pin 2 and Pin 3
TC	Thermocouple type	k	-200...+1300 °C
		b	250...1820 °C
		E	-200...+1000 °C
		J	-210...+1200 °C
		n	-200...+1300 °C
		R	-50...+1500 °C
		S	-50...+1500 °C
		T	-200...+400 °C
EF	Submenu for additional setting options		See table "Parameters in the EF submenu"

9.2.6 Parameters in the EF (Extended Functions) submenu

	Explanation	Options	Function
Hi	Maximum value memory		The highest process temperature is stored and can be displayed/deleted (press and hold [SET]).
Lo	Minimum value memory		The lowest process temperature is stored and can be displayed/deleted here (hold down [SET]).
CoF	Offset adjustment		Severe temperature changes in the environment of the sensor can cause shifting of the zero point. As a result, the measured value zero is not displayed at 0 °C . This drift can be corrected with the offset value. Adjustment range: -55...+55 °C in increments of 0.1 K. Default: 0.0 °C
dSP1	Switching delay of SP1		0...60 s in increments of 0.1 s (0 = delay time not active) Default: 0.0 s
drP1	Switching delay of rP1		0...60 s in increments of 0.1 s (0 = delay time not active) Default: 0.0 s
dFH1	Switching delay of FH1		0...60 s in increments of 0.1 s (0 = delay time not active), only available with window mode Fno or Fnc Default: 0.0 s
dFL1	Switching delay of FL1		0...60 s in increments of 0.1 s (0 = delay time not active), only available with window mode Fno or Fnc Default: 0.0 s
dSP2	Switching delay of SP2		0...60 s in increments of 0.1 s (0 = delay time not active). Default: 0.0 s
drP2	Switching delay of rP2		0...60 s in increments of 0.1 s (0 = delay time not active). Default: 0.0 s
dFH2	Switching delay of FH2		0...60 s in increments of 0.1 s (0 = delay time not active), only available with window mode Fno or Fnc Default: 0.0 s
dFL2	Switching delay of FL2		0...60 s in increments of 0.1 s (0 = delay time not active), only available with window mode Fno or Fnc Default: 0.0 s
FOU1	Behavior of output 1 in the event of an error (not a short circuit)	ON	Binary output: The output is activated in the event of an error.
		OFF	Binary output: The output is deactivated in the event of an error.

	Explanation	Options	Function
FOU2	Behavior of output 2 in the event of an error (not a wire break or short circuit)	ON	Binary output: The output is activated in the event of an error. Analog output: Error value of the set function at output 2 (ou2)
		OFF	Binary output: The output is deactivated in the event of an error. Analog output: Error value of the set function at output 2 (ou2)
P-n	Behavior of switching output	Auto	Automatic detection (NPN/PNP)
		NPN	N switching
		PNP	P switching
diSr	Display orientation	0°	Display rotated by 0°
		180°	Display rotated by 180°
diSu	Measurement value display	50	50-ms update time
		200	200-ms update time
		600	600-ms update time
		OFF	The display does not show any values during operation. The status LEDs remain active. The value on the display appears when you touch the touch pads.
coLr	Display color	GrEn	Always green
		rEd	Always red
		G1ou	Green if ou1 is switched, otherwise red
		r1ou	Red if ou1 is switched, otherwise green
		G2ou	Green if ou2 is switched, otherwise red
		r2ou	Red if ou2 is switched, otherwise green
		G-cF	Green if the measured value is between the switching points cFL and cFH
		r-cF	Red if the measured value is between the switching points cFL and cFH
cFH	Virtual upper switching point		Upper switching point at which the display changes color (if display color G-cF or r-cF is selected) Default: 80.0 °C
cFL	Virtual lower switching point		Lower switching point at which the display changes color (if display color G-cF or r-cF is selected) Default: 70.0 °C
PASS	Password protection		Set password and activate password protection
		0000	No password
rES	Reset	FACT	Reset the parameters to the default settings
		Undo	Reset the parameters to the previous settings (last device start)
		rEbo	Device restart (warm start)
SoF	menu navigation	StD	Standard menu navigation
		VdMA	VDMA menu navigation

9.3 Setting via IO-Link

The device can be parameterized within the technical specifications (see data sheet) via the IO-Link communication interface – both offline, e.g. with the configuration tool as well as also online via the controller. An overview of the different functions and properties that can be set and used for IO-Link or SIO mode can be found in the chapter “Setting and parameterization” and via the IO-Linkfinder. Detailed instructions on the parameterization of devices via the IO-Link interface are provided in the IO-Link commissioning manual.

All parameters can be changed in IO-Link mode via the controller, both during commissioning and during operation. In SIO mode, the device operates in accordance with the most recent setting configured in IO-Link mode.

10 Troubleshooting

If the device does not function as expected, first check whether ambient interference is present. If there is no ambient interference present, check the connections of the device for faults.

If there are no faults, there is a device malfunction. In this case, decommission the device and replace it with a new device of the same type.

11 Maintenance

The device is maintenance-free. Clean with a damp cloth if required.

12 Repair

The device must not be repaired by the user. The device must be decommissioned if it is faulty. Observe our return acceptance conditions when returning the device to Turck.

12.1 Returning devices

Returns to Turck can only be accepted if the device has been equipped with a Decontamination declaration enclosed. The decontamination declaration can be downloaded from <https://www.turck.de/en/retoure-service-6079.php> and must be completely filled in, and affixed securely and weather-proof to the outside of the packaging.

13 Disposal



The devices must be disposed of correctly and must not be included in general household garbage.

14 Technical data

Technical data	TS720-2UPN8-H1141	TS720-LI2UPN8-H1141
ID	100003633	100003640
Temperature range		
Temperature display range	-210...1820 °C -346...3308 °F	
Measuring element	For connection to probes of the TP series	
Response time	100 ms	
Electrical data		
Operating voltage	10...33 VDC	17...33 VDC
Current consumption	≤ 200 mA	
Voltage drop at I _e	≤ 2 V	
Protective measure	SELV, PELV according to DIN EN 61140	
Short-circuit/reverse polarity protection	Yes/yes	
Protection class	III	
Outputs		
Output 1	Switching output or IO-Link mode	
Output 2	Switching output	Analog or switching output
Switching output		
Communication protocol	IO-Link	
Output function	NC/NO programmable, PNP/NPN	
Switching point accuracy	± 0.2 K	
Rated operational current	0.25 A	
Switching point distance	≥ 0.2 K	
Switch point(s)	Probe dependent: (min. measuring range + 0.2 K) ... (max. measuring range)	
Release point(s)	Probe dependent: (min. measuring range) ... (max. measuring range — 0.2 K)	
Switching cycles	≥ 100 million	
Repetition accuracy	0.1 K	
Analog output		
Current output	–	0...20 mA/4...20 mA, each invertible
Load resistance, current output	–	≤ 0.5 kΩ
Voltage output	–	0...5 V/0...10 V/0.5...4.5 V/ 1...6 V, each invertible
Voltage output load resistance	–	≥ 8 kΩ
Accuracy (Lin. + Hys. + Rep.)	–	± 0.3 K (or 0.1% of scale at > 200 °C)
Repetition accuracy	–	0.1 K

Technical data	TS720-2UPN8-H1141	TS720-LI2UPN8-H1141
IO-Link		
IO-Link specification	V1.1	
Physical transmission layer	Corresponds to 3-wire technology (PHY2)	
Frame type	2.2	
Transmission rate	COM 2 (38.4 kBaud)	
Parameterization	FDT/DTM/selection of various mapping profiles	
Accuracy	± 0.1 K	
Included in the SIDI GSDML	Yes	
Programming		
Programming options	Automatic switch logic detection, switch/release points; Hysteresis/window mode; NO/NC contact; Unit; IO-Link mapping profiles	Automatic switch logic detection, switch/release points; hysteresis/window mode; NO/NC contact; unit; IO-Link mapping profiles; analog output 0/4...20 mA, 0/2...10 VDC, 0/1...5 VDC, 0.5...4.5 VDC
Mechanical data		
Housing material	Stainless steel/plastic, 1.4404 (AISI 316L)/Grilamid TR90 UV	
Electrical connection	Male connector, M12 × 1	
Type of protection	IP66/IP67/IP69K (not UL approved)	
Electromagnetic compatibility (EMC)	EN 61326-2-3: 2013 minimum operating quality: +3.0 K under worst possible conditions	
Environmental Conditions		
Ambient temperature	-40...+80 °C	
Storage temperature	-40...+85 °C	
Shock resistance	50 g (11 ms), DIN EN 60068-2-27	
Vibration resistance	20 g (10...3000 Hz), DIN EN 60068-2-6	
Application range (UL)	Indoor application	
Tests/approvals		
Approvals	UL	
UL registration number	E516036	
Reference conditions acc. to IEC 61298-1		
Temperature	15...25 °C	
Atmospheric pressure	860...1060 hPa abs.	
Air humidity	10...95 % rel.	
Auxiliary power	24 VDC	
Display	4-digit 2-color (green/red) 12-segment display, rotatable by 180°	
Switching state indication	2 × LEDs, yellow	
Unit display	4 × green LED (°C, °F, K, ohm)	

15 Turck subsidiaries — contact information

Germany	Hans Turck GmbH & Co. KG Witzlebenstraße 7, 45472 Mülheim an der Ruhr www.turck.de
Australia	Turck Australia Pty Ltd Building 4, 19-25 Duerdin Street, Notting Hill, 3168 Victoria www.turck.com.au
Austria	Turck GmbH Graumanngasse 7/A5-1, A-1150 Wien www.turck.at
Belgium	TURCK MULTIPROX Lion d'Orweg 12, B-9300 Aalst www.multiprox.be
Brazil	Turck do Brasil Automação Ltda. Rua Anjo Custódio Nr. 42, Jardim Anália Franco, CEP 03358-040 São Paulo www.turck.com.br
Canada	Turck Canada Inc. 140 Duffield Drive, CDN-Markham, Ontario L6G 1B5 www.turck.ca
China	Turck (Tianjin) Sensor Co. Ltd. 18,4th Xinghuazhi Road, Xiqing Economic Development Area, 300381 Tianjin www.turck.com.cn
Czech Republic	TURCK s.r.o. Na Brne 2065, CZ-500 06 Hradec Králové www.turck.cz
France	TURCK BANNER S.A.S. 11 rue de Courtalin Bat C, Magny Le Hongre, F-77703 MARNE LA VALLEE Cedex 4 www.turckbanner.fr
Great Britain	TURCK BANNER LIMITED Blenheim House, Hurricane Way, GB-SS11 8YT Wickford, Essex www.turckbanner.co.uk
Hungary	TURCK Hungary kft. Árpád fejedelem útja 26-28., Óbuda Gate, 2. em., H-1023 Budapest www.turck.hu
India	TURCK India Automation Pvt. Ltd. 401-403 Aurum Avenue, Survey. No 109 /4, Near Cummins Complex, Baner-Balewadi Link Rd., 411045 Pune - Maharashtra www.turck.co.in
Italy	TURCK BANNER S.R.L. Via San Domenico 5, IT-20008 Bareggio (MI) www.turckbanner.it
Japan	TURCK Japan Corporation ISM Akihabara 1F, 1-24-2, Taito, Taito-ku, 110-0016 Tokyo www.turck.jp

Korea	Turck Korea Co, Ltd. B-509 Gwangmyeong Technopark, 60 Haan-ro, Gwangmyeong-si, 14322 Gyeonggi-Do www.turck.kr
Malaysia	Turck Banner Malaysia Sdn Bhd Unit A-23A-08, Tower A, Pinnacle Petaling Jaya, Jalan Utara C, 46200 Petaling Jaya Selangor www.turckbanner.my
Mexico	Turck Comercial, S. de RL de CV Blvd. Campestre No. 100, Parque Industrial SERVER, C.P. 25350 Arteaga, Coahuila www.turck.com.mx
Netherlands	Turck B. V. Ruiterlaan 7, NL-8019 BN Zwolle www.turck.nl
Poland	TURCK sp.z.o.o. Wroclawska 115, PL-45-836 Opole www.turck.pl
Romania	Turck Automation Romania SRL Str. Siriului nr. 6-8, Sector 1, RO-014354 Bucuresti www.turck.ro
Russian Federation	TURCK RUS OOO 2-nd Pryadilnaya Street, 1, 105037 Moscow www.turck.ru
Sweden	Turck Sweden Office Fabriksstråket 9, 433 76 Jonsered www.turck.se
Singapore	TURCK BANNER Singapore Pte. Ltd. 25 International Business Park, #04-75/77 (West Wing) German Centre, 609916 Singapore www.turckbanner.sg
South Africa	Turck Banner (Pty) Ltd Boeing Road East, Bedfordview, ZA-2007 Johannesburg www.turckbanner.co.za
Turkey	Turck Otomasyon Ticaret Limited Sirketi Inönü mah. Kayisdagi c., Yesil Konak Evleri No: 178, A Blok D:4, 34755 Kadiköy/ Istanbul www.turck.com.tr
USA	Turck Inc. 3000 Campus Drive, USA-MN 55441 Minneapolis www.turck.us

TURCK

Over 30 subsidiaries and
60 representations worldwide!

100020588 | 2022/06



www.turck.com