

Your Global Automation Partner

TURCK

PSU67-3P-1S-2L-24250-IOL-F
Smart switching power
supply in IP65/IP67

Instructions for Use

Table of Contents

1	About these instructions	4
1.1	Target groups	4
1.2	Explanation of symbols used	4
1.3	Additional documents	4
1.4	Feedback about these instructions	4
2	Notes on the product	5
2.1	Product identification	5
2.2	Scope of delivery	5
2.3	Turck service	5
3	For your safety	6
3.1	Intended use	6
3.2	Foreseeable misuse	6
3.3	General safety notes	6
4	Product description	7
4.1	Device overview	7
4.1.1	Block diagram	8
4.1.2	Operating elements	8
4.1.3	Display elements	8
4.2	Properties and features	8
4.3	Functional principle	8
4.4	Functions and operating modes	9
4.4.1	User interface	9
4.4.2	AC voltage input	9
4.4.3	DC voltage outputs	10
4.4.4	IO-Link interface	12
5	Installing	13
5.1	Special installation instructions – mounting altitude	13
6	Connecting	14
6.1	Connecting the AC input voltage	14
6.2	Connecting the DC output voltage side	14
6.3	Connecting the device to IO-Link	14
7	Commissioning	15
8	Setting	16
8.1	Setting the device via LED bar and pushbuttons	16
8.1.1	Switching outputs on or off	16
8.1.2	Resetting outputs	16
8.1.3	Activating and deactivating the button lock	16
8.2	Setting the device via IO-Link	17
8.2.1	Direct Parameter Page 1	17
8.2.2	Identification	17
8.2.3	Index 0x02: System commands (according to IO-Link specification)	18
8.2.4	Index 0x0C: Device Access Locks	18
8.2.5	Parameters	19

9	Operating	23
9.1	Monitoring mode.....	23
9.2	LED displays	23
9.3	Process data (cyclic IO-Link data)	25
9.4	Diagnostic and status messages (acyclic IO-Link data)	26
9.5	IO-Link Events.....	30
9.6	IO-Link error codes	31
10	Maintenance	32
11	Repair	32
11.1	Returning devices	32
12	Disposal	32
13	Technical data	33
13.1	AC input	33
13.2	DC output	35
13.3	Efficiency and power losses	37
13.4	IO-Link interface.....	37
13.5	General technical data	38
14	Turck subsidiaries — contact information	41

1 About these instructions

These instructions for use describe the structure, functions and the use of the product and will help you to operate the product as intended. Read these instructions carefully before using the product. This is to avoid possible damage to persons, property or the device. Retain the instructions for future use during the service life of the product. If the product is passed on, pass on these instructions as well.

1.1 Target groups

These instructions are aimed at qualified personal and must be carefully read by anyone mounting, commissioning, operating, maintaining, dismantling or disposing of the device.

1.2 Explanation of symbols used

The following symbols are used in these instructions:



DANGER

DANGER indicates a dangerous situation with high risk of death or severe injury if not avoided.



WARNING

WARNING indicates a dangerous situation with medium risk of death or severe injury if not avoided.



CAUTION

CAUTION indicates a dangerous situation of medium risk which may result in minor or moderate injury if not avoided.



NOTICE

NOTICE indicates a situation which may lead to property damage if not avoided.



NOTE

NOTE indicates tips, recommendations and useful information on specific actions and facts. The notes simplify your work and help you to avoid additional work.



CALL TO ACTION

This symbol denotes actions that the user must carry out.



RESULTS OF ACTION

This symbol denotes relevant results of actions.

1.3 Additional documents

Besides this document, the following material can be found on the Internet at www.turck.com:

- Data sheet
- Declarations of Conformity (current version)
- Quick Start Guide
- Approvals

1.4 Feedback about these instructions

We make every effort to ensure that these instructions are as informative and as clear as possible. If you have any suggestions for improving the design or if some information is missing in the document, please send your suggestions to techdoc@turck.com.

2 Notes on the product

2.1 Product identification

These instructions apply to the following IP65/IP67 power supply series PSU67:

- PSU67-3P-1S-2L-24250-IOL-F (ID 100025929)

2.2 Scope of delivery

The scope of delivery includes:

- IP65/IP67 power supply
- Quick Start Guide

2.3 Turck service

Turck supports you with your projects, from initial analysis to the commissioning of your application. The Turck product database under www.turck.com contains software tools for programming, configuration or commissioning, data sheets and CAD files in numerous export formats.

The contact details of Turck subsidiaries worldwide can be found on p. [▶ 41].

3 For your safety

The product is designed according to state-of-the-art technology. However, residual risks still exist. Observe the following warnings and safety notices to prevent damage to persons and property. Turck accepts no liability for damage caused by failure to observe these warning and safety notices.

3.1 Intended use

The power supply unit PSU67-3P-1S-2L-24250-IOL-F is a stand-alone power supply for three-phase mains systems for indoor use with IO-Link interface. The device is designed with IP65/IP67 protection and is suitable for use directly on the machine. The protection class can only be guaranteed if all mating connectors are firmly connected.

The switching power supply converts an AC input voltage of 320...550 VAC into a 24 VDC output voltage and makes it available at four current-limited outputs. The unit's four outputs are protected by internal electronic fuses (eFuse). The unit is suitable for use at altitudes up to 5000 m (16400 ft). Above 2000 m (6560 ft), the output current and overvoltage category must be reduced.

The devices may only be used as described in these instructions. Any other use is not in accordance with the intended use. Turck accepts no liability for any resulting damage.

3.2 Foreseeable misuse

- Do not operate the power supply unit with DC input voltage.

3.3 General safety notes

- The device may only be assembled, installed, operated, parameterized and maintained by professionally-trained personnel.
- The device may only be used in accordance with applicable national and international regulations, standards and laws.
- The device meets the EMC requirements for industrial areas. When used in residential areas, take measures to avoid radio interference.
- The device is class of protection I equipment according to IEC 61140.
- The device is designed for pollution degree 3 areas in controlled environments.
- Only use the device with additional protective devices in the area of personal and machine protection.
- Operate the device exclusively within the technical specifications.
- Do not connect the negative potential of any output externally to PE.
- Do not use without a proper PE (Protective Earth) connection.

4 Product description

The 3-phase switching power supply PSU67-3P-15-2L-24250-IOL-F is designed in IP65/IP67. An S-coded M12 connector (XD1) is available for connecting the input voltage. The output voltage side is connected via two L-coded M12 sockets (XD2 and XD3). The device has four internal eFuses to protect the output voltage.

The IO-Link interface is designed as an A-coded M12 connector (X0). Configuration and diagnostics are performed either directly on the device via the operator interface (LEDs and buttons) or via IO-Link.

Mating connectors

- Input voltage (XD1): M12 female connector, S-coded, 4-pin
- Output voltage (XD2, XD3): M12 male connector, L-coded, 5-pin
- IO-Link (X0): M12 female connector, A-coded, 5-pin

4.1 Device overview

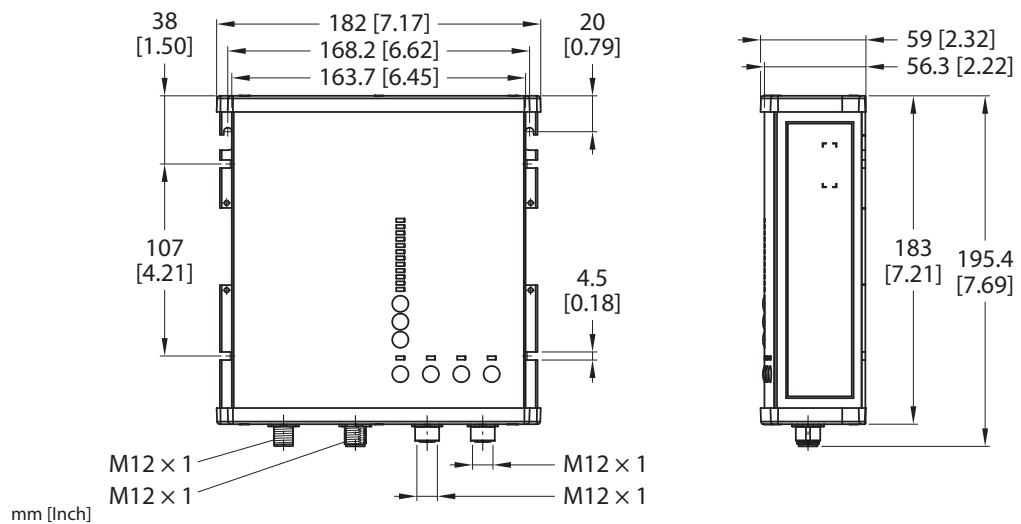

Fig. 1: Dimensions

4.4 Functions and operating modes

4.4.1 User interface

Output level control

The buttons [Voltage Set] and [\uparrow] [\downarrow] are used to configure output voltage and trip current in the configuration mode Konfigurationsmodus. After commissioning the power supply, the device is in monitoring mode (normal operation) for monitoring the output power.

Output control

The output LEDs (OUT1...OUT4) indicate the operating states of the corresponding outputs. The respective output is switched on and off via the associated button.

4.4.2 AC voltage input

The voltage input is designed for a 3-phase AC voltage of $3 \times 380 \dots 480$ VAC (nominal range).

Inrush current limitation

The power supply is equipped with an active inrush current limiting circuit, which limits the input inrush current to a very low value after switching on. The inrush current is usually lower than the permanent input current.

	3AC 400 V	3 AC, 480 V	
Inrush current	Max. 2.1 A _{peak} Typ. 1.9 A _{peak}	Max. 2 A _{peak} Typ. 1.8 A _{peak}	Temperature independent

The charging current in the EMI suppression capacitors is neglected in the first microseconds after switch-on.

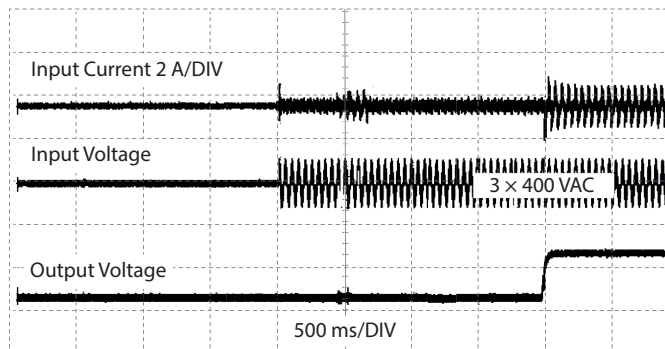

Fig. 3: Typical switch-on behavior at nominal load and 25 °C ambient temperature

Input protection

The unit is designed, tested and approved for branch circuits up to 32 A (IEC) and 20 A (UL) without additional protective device.

If an external fuse is used, type B or C circuit breakers of at least 6 A have to be used to prevent unwanted tripping of the circuit breaker.

Phase failure protection (2-phase operation)

No external protective devices are required for protection against phase failure. Continuous 2-phase operation is not recommended for this power class since the supplying 3-phase network could become unbalanced.

However, if one phase fails, the unit may continue to operate if the load is below the power limit (s. fig.: Performance in 2-phase operation). Exceeding of these limits for an extended period may result in a thermal shut-down of the unit.

During power-on, some start-up attempts can occur until a permanent output power is available. EMC performance, hold-up time, losses, and output ripple differ from a three 3-phase operation. Such use is not included in the approval according to UL 61010 and IEC 62368.

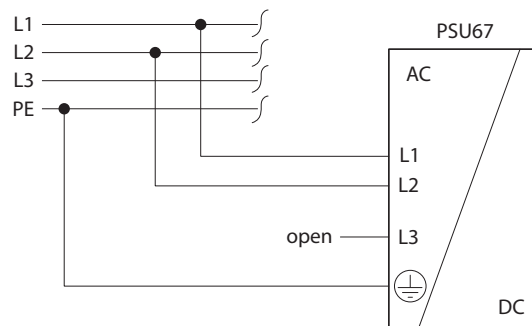

Fig. 4: 2-phase operation

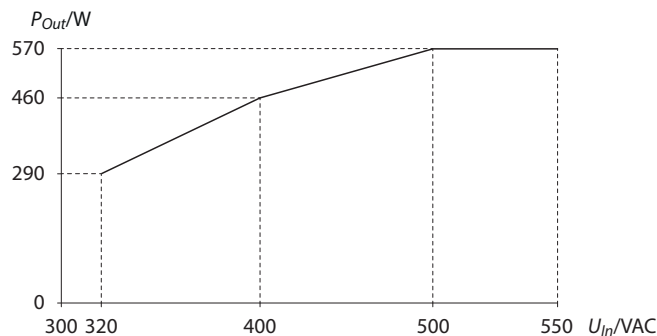

Fig. 5: Performance in 2-phase operation

4.4.3 DC voltage outputs

The DC voltage outputs OUT1...OUT4 provide a stabilized and galvanically isolated 24 VDC output voltage (PELV/ES1). The negative potential of the outputs is permanently connected to PE in the device. The outputs are electronically protected against open-circuit, overload and short-circuit and can supply any type of loads, including unlimited inductive and capacitive loads.

When connecting capacitors with capacitance >20 mF to an output, this output may be switched off after switching on the device or the output or connecting the load. All outputs are individually current limited. If an overload occurs, the individual output switches off and must be reset manually via the associated button or via IO-Link. The output can be reset at the earliest 5 s after it has been switched off.

The outputs of the device are switched on in the delivery state. The outputs are not switched off in a safety-related manner.

The sum of the configured output power of all outputs can exceed the total output power. In this case, the outputs switch off one after the other in reverse order (OUT4, OUT 3, ...) until the total output power is within the permissible range again. The lower output in each case remains switched on to prevent voltage dips and to output current continuously.

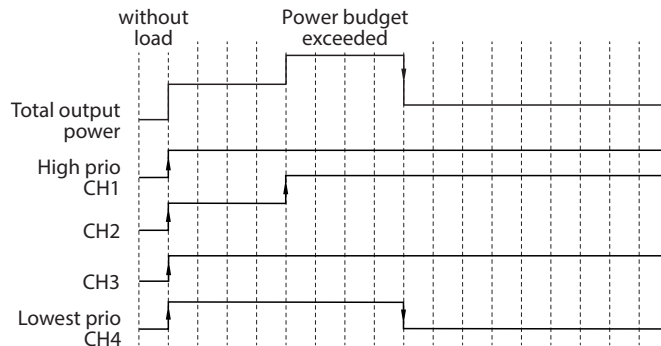

Fig. 6: Tripping of the channel with the lowest priority when the total output power is exceeded

After having been switched off, the outputs start automatically one after the other at intervals of 150 ms in the sequence OUT1...OUT4.

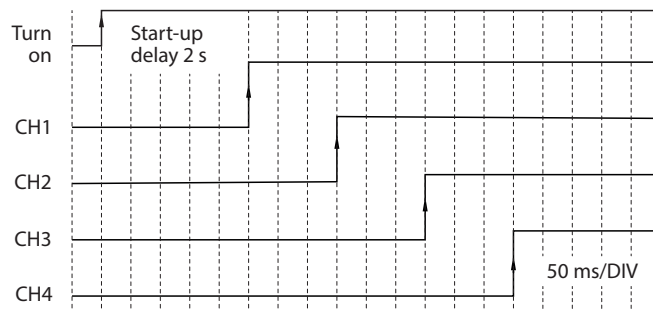

Fig. 7: Sequential start of outputs

Hold-up time

The hold-up time is the time during which a power supply's output voltage remains within specification following the loss of input power. The hold-up time is output load dependent. At no load, the hold-up time can be up to several seconds. The status LED is on during this time.

	3 AC, 400 V/480 V	Output load
Hold-up time	Typ. 56 ms Min. 47 ms	250 W
	Typ. 24 ms Min. 20 ms	500 W

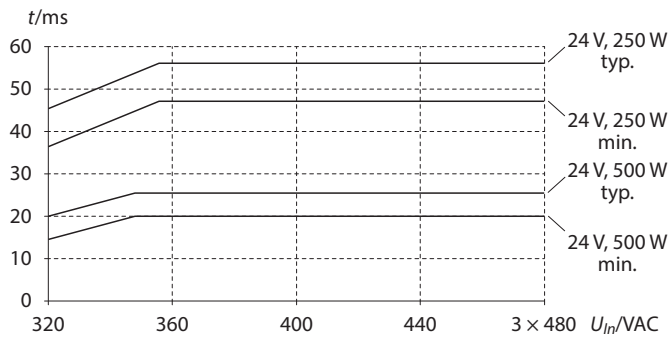

Fig. 8: Hold-up time vs. input voltage

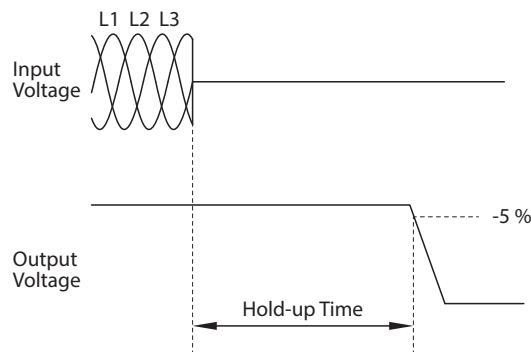

Fig. 9: Shutdown behavior

Support of short-term peak loads

The device is designed to support loads with a higher short-term power demand (peak loads). Temporary peak loads cause an increased power demand for a short time, which is controlled internally in the device by an output power manager. If the average load exceeds the sum of all output powers, the output voltage collapses.

To avoid a collapse of the output voltage, observe the following rules:

- The power demand of the short-time load pulse must be below 200 % of the nominal output power.
- The duration of the load pulse must be shorter than the max. permissible duration for the additional power.
- The average power should be lower than the rated output power.
- The RMS output current must be lower than the specified continuous output current. Continuous increased RMS current may cause thermal shutdown of the device.

4.4.4 IO-Link interface

The devices (PSU67-...-IOL) have an IO-Link interface V1.1 for connection to IO-Link masters. The device can be parameterized via IO-Link using the associated IO-DD. In addition, device-internal measurement data and diagnostics are made available via IO-Link. The IO-DDs are available for download free of charge at www.turck.com.

The devices can also be operated without active IO-Link communication. Settings made via IO-Link during commissioning for example, are stored in the EEPROM of the device and are available even if the IO-Link communication fails.

5 Installing

The housing of the device ensure IP65 and IP67 protection when all mating connectors are firmly connected.



CAUTION

Sharp edges on the back of the device

Risk of injury

- ▶ Mount the devices on a sufficiently large, even surface so that all sharp edges are covered.

-
- ▶ Mount the device vertically with the connection level facing downwards on a flat surface using two M4 screws each at the upper and lower mounting holes.
 - ▶ Other mounting orientations: Reduce the output current (▶ 38]).
 - ▶ Do not obstruct airflow. Do not cover ventilation fins.
 - ▶ Observe the minimum installation clearances: 50 mm on top and bottom, 10 mm on the front and 10 mm left and right side.

Device cooling

The device uses convection cooling. An external fan is not necessary.

5.1 Special installation instructions – mounting altitude

The device is generally designed for altitudes up to 5000 m (16400 ft). The devices may only be used as described in these instructions. Above 2000 m (6560 ft), the output current and overvoltage category must be reduced.

When using the device in TN, TT and IT networks the following applies:

- TN, TT mains systems with earthed neutral and IT star mains systems with insulation monitoring: Use in zones of overvoltage category III up to an altitude of 2000 m (6560 ft), use in zones of overvoltage category II up to an altitude of 5000 m (16400 ft)
- TN, TT, IT delta mains systems or IT star mains systems without insulation monitoring: Use in zones of overvoltage category II up to 2000 m (6560 ft)

6 Connecting

6.1 Connecting the AC input voltage

The device has a 4-pin, S-coded M12 connector for connecting the AC input voltage. The maximum tightening torque is 0.6 Nm.

- ▶ Connect the AC input voltage to the device according to the pin assignment below.

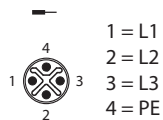

Fig. 10: Pin assignment — M12 connector, AC input voltage (XD1)

6.2 Connecting the DC output voltage side

The device has two 5-pin, L coded M12 connectors for connecting the DC output voltage side. The maximum tightening torque is 0.6 Nm.

- ▶ Connect the output voltage side according to the pin assignment shown below.

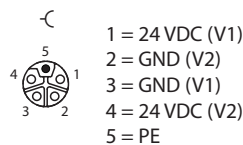

Fig. 11: Pin assignment — M12 connector, DC output voltage side (XD2, XD3)

Notes on connecting loads

- ▶ Only connect return voltages < 35 V from a load to the outputs.
- ▶ Do not connect outputs or devices in parallel.

6.3 Connecting the device to IO-Link

For the connection to IO-Link, the device has a 5-pin, A-coded M12 connector. The maximum tightening torque is 0.6 Nm.

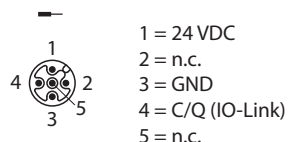

Fig. 12: Pin assignment - IO-Link interface (X0)

7 Commissioning

After connecting the wires and by switching on the AC input voltage, the device automatically goes into operation.

8 Setting

8.1 Setting the device via LED bar and pushbuttons

The device has an LED bar and three buttons for monitoring output power and channel output current (monitoring mode ▶ 23]) and for configuring output voltage and trip current. In configuration mode, the output voltage and trigger current can be set to monitor the current of the outputs OUT1...OUT4.

In addition, a button lock can be set up and the outputs of the device can be switched on or off independently.

8.1.1 Switching outputs on or off

The outputs can be switched on or off independently of each other. In the delivery state, all outputs of the device are switched off.

- ▶ Press and hold the button on the output channel (OUT1...OUT4) for 1 s to switch a channel on or off manually.

8.1.2 Resetting outputs

In case of an error at the output:

- ▶ Press and hold the button on the output (OUT1...OUT4) for longer than 1 s to reset the output.

8.1.3 Activating and deactivating the button lock

Activate button lock

- ▶ Hold [↑] and [↓] buttons simultaneously for 3 s.
- ⇒ All LEDs flash for 5 s to indicate that the key lock status has changed. The display returns to normal operation.

Check button lock

- ▶ Press and hold the [Voltage Set] key for 3 s.
- ⇒ If the button lock is activated, all LEDs flicker for 5 s.

Remove button lock

- ▶ Hold [↑] and [↓] buttons simultaneously for 3 s.
- ⇒ All LEDs flash for 5 s to indicate that the key lock status has changed. The display returns to normal operation.

8.2 Setting the device via IO-Link

8.2.1 Direct Parameter Page 1

ISDU Index Hex. (dec.)	Sub index	Object name	Access Read (R) Write (W)	Length in byte	Meaning
0x00 (0)		Direct Parameter Page 1	R	16	
	0x02	Master cycle time	R	1	
	0x03	Min. cycle time	R	1	
	0x04	M sequence capability	R	1	
	0x05	IO-Link version ID	R	1	17
	0x06	Process data input length	R	1	
	0x07	Process data output length	R	1	
	0x08 0x09	Vendor ID	R	2	ID for Turck: 0x013D
	0x0A 0x0B 0x0C	Device ID	R	3	E. g.: PSU67-3P-1S-2L-24250-IOL-F: 2228224 (0x220000)
	0x10	Standard command	R/W	1	129: application reset 130: restore factory settings

8.2.2 Identification

ISDU Index Hex. (dec.)	Object name	Access Read (R) Write (W)	Length in byte	Meaning
0x10 (16)	Vendor name	R	16	Turck
0x11 (17)	Vendor text	R	32	www.turck.com
0x12 (18)	Product name	R	32	PSU67-...
0x13 (19)	Product ID	R	16	ID of the device
0x14 (20)	Product text	R	32	IP67 Power Supply
0x15 (21)	Serial number	R	16	Sequential serial number
0x16 (22)	Hardware revision	R	8	Hardware revision of the device, e. g. V1.0
0x17 (23)	Firmware revision	R/W	16	Firmware revision of the device, e. g. V1.0.7.0
0x18 (24)	Application Specific Tag	R/W	32	Default "****" Field for customer or application specific data

ISDU Index Hex. (dec.)	Object name	Access Read (R) Write (W)	Length in byte	Meaning
0x19 (36)	Function Tag	R/W	32	Default "****" Field for the application specific device function
0x1A (26)	Location Tag	R/W	32	Default "****" Field for the application-specific installation location of the device

8.2.3 Index 0x02: System commands (according to IO-Link specification)

Command	
129	Application reset
130	Restore factory settings

8.2.4 Index 0x0C: Device Access Locks

Default values are shown in **bold**.

Sub index Hex. (dec.)	Object name	Bit offset	Data type	Meaning
1	Parameter (write) access lock	0	BOOL	Not implemented
2	Data storage lock	1		0: not activated (default) 1: activated
3	Local parameterization lock	2		Not implemented
4	Local user interface lock	3		Not implemented

8.2.5 Parameters

Parameter overview

Index Hex. (dec.)	Sub index	Parameter name	Data type	Length in bit	Unit	Access Read (R) Write (W)
0x65 (101)	0	Standby	BOOL	8		RW
0x67 (103)	0	Configuration setting	UINT8	8		RW
0x68 (104)	0	PSU total output current Pre-alarm level	UINT16	16	2 ⁻⁸ A/bit	RW
0x69 (105)	0	Output Voltage Setpoint	UINT16	16	2 ⁻⁸ V/Bit	RW
0x6A (106)	0	eFuses channel on/off	Set of BOOL	8	-	RW
0x6C (108)	0	eFuse trip value Ch1	UINT16	16	2 ⁻⁸ A/bit	RW
	1	...				
	2					
	3	eFuse trip value CH4				
0x6D (109)	0	eFuses pre-alarm level Ch1	UINT8	8	2 ⁻⁷ /Bit (0.78 %/ Bit)	RW
	1	...				
	2					
	3	eFuses pre-alarm level Ch4				

Standby — index 0x65 (101)

This parameter can be used to actively set the device to the "standby" state.

Format	Length
BOOL	1 bit

Default values are shown in **bold**.

Value	Meaning
0	False PSU normal operation
1	True PSU standby Power supply in standby mode, all outputs are switched off

Configuration setting — index 0x67 (103)

This parameter defines the interface via which the device can be configured. In addition, the device can also be locked against configuration.

Format	Length
UINT8	8 bit

Default values are shown in **bold**.

Value	Meaning
0	Human-machine interface only Configuration of the device only possible directly on the device via the user interface
1	IO-Link only Configuration of the device only possible via IO-Link (IODD)
2	Both Configuration of the device possible both directly on the device and via IO-Link (IODD)
3	None (button lock) Configuration locked

Total converter current pre-alarm level — index 0x68 (104)

This parameter defines pre-alarm level for the total current.

Format	Length
UINT16	16 bit

Default values are shown in **bold**.

Unit: 2^{-8} A/bit
Value range: 256...25600 = 1...100 A
Default value: **5120 = 20 A**

Output voltage setpoint — index 0x69 (105)

This parameter defines the setpoint for the output voltage.

Format	Length
UINT16	16 bit

Default values are shown in **bold**.

Unit: 2^{-8} V/bit
Value range: 6144...7168 = 24...28 V
Default value: **6272 = 24.5 V**

eFuse ch... on/off — index 0x6A (106)

This parameter enables the eFuse to be switched on and off for the respective channel.

Format	Length
BOOL	8 bit

Default values are shown in **bold**.

Sub index	Object name	Bit offset	Value	Meaning
1	eFuse ch1 on/off	0	0	eFuse for channel 1 switched off
			1	eFuse for channel 1 switched on
2	eFuse ch2 on/off	1	s. channel 1	
3	eFuse ch3 on/off	2		
4	eFuse ch4 on/off	3		

eFuse trip value ch... — index 0x6C (108)

This parameter defines the trigger value of the eFuse for the respective channel.

Format	Length
UINT16	2 bytes per channel

Sub index	Object name	Bit offset
1	eFuse trip value Ch1	63...48
2	eFuse trip value Ch2	47... 32
3	eFuse trip value Ch3	31...16
4	eFuse trip value Ch4	15...0

Default values are shown in **bold**.

Unit: 2^{-8} A/bit
 Value range: 256...3072 = 1...12 A V
 Default value: **3072 = 12 A**

Assignment								
Byte	0	1	2	3	4	5	6	7
Bit offset	63...56	55...48	47...40	39...32	31...24	23...16	15...8	7...0
Sub index	1	1	2	2	3	3	4	4
Bit order	15...8	7...0	15...8	7...0	15...8	7...0	15...8	7...0
Trip value	Channel 1		Channel 2		Channel 3		Channel 4	

eFuse pre-alarm level ch... — index 0x6D (109)

This parameter defines the value (in percent) from which a pre-alarm is generated for the subsequent triggering of the eFuse at the respective channel.

Format	Length
32-bit record (UINT8)	8 bit per channel

Sub index	Object name	Bit offset
1	eFuses pre-alarm level Ch1	24
2	eFuses pre-alarm level Ch2	16
3	eFuses pre-alarm level Ch3	8
4	eFuses pre-alarm level Ch4	0

Default values are shown in **bold**.

Unit: 2^{-7} %/bit
 Value range: 13...192 = 10.17...150 %
 Default value: **103 = 80.46875 %**

Assignment				
Byte	0	1	2	3
Bit offset	31...24	23...16	15...8	7...0
Sub index	1	2	3	4
Bit order	7...0	7...0	7...0	7...0
Trip value	Channel 1	Channel 2	Channel 3	Channel 4

9 Operating

9.1 Monitoring mode

Mode: Monitoring output power (normal operation)

In the "Monitoring output power" mode, the LEDs display the current output power as a percentage of 500 W (50 % = 250 W, 100 % = 500 W). For values above 100 %, the orange 125 % LED flashes. Immediately after switching on, the LEDs display the total output power.

Mode: Monitoring channel output current

- ▶ In the "Monitoring output power" mode (normal operation), press [↑] [↓] buttons to switch to the "Monitoring channel output current" mode.
- ⇒ The LED OUT1 lights up constantly orange. The current output current for output 1 is displayed via the LED bar (2...12 A).
- ▶ Press [↑] [↓] buttons to change the output channel.
- ▶ To change to normal operation: Press [↑] oder [↓] buttons until OUT1 or OUT4 is skipped.
- ⇒ When all channel LEDs are off, the unit is back in normal mode for monitoring the total output power.

9.2 LED displays

The unit has the following LED indicators:

- Operating status (Status)
- Output power in % (%-LEDs)
- Channel LEDs (OUT1...OUT4)

LED %	Meaning
0...100 %	
Green	The DC output power is 20...100 % of the max. output power.
> 100 %	
Orange	The DC output power above 100 % of the max. output power.

STATUS LED	Meaning
Green	The DC output voltage is above 90 % of the setpoint voltage. All outputs operate according to their settings.
Off	Possible causes: <ul style="list-style-type: none"> ■ The DC output voltage is below 90 % of the setpoint voltage: ■ An output channel has tripped: ■ The power supply is not switched on:
Red	AC input voltage too low
Orange flashing	Output switched off and in Hiccup Plus mode (18 s)
Red flashing	The device has switched off due to overtemperature. As soon as the temperature reaches the normal operating range, the output switches on again and the STATUS LED lights up permanently green.

LED OUT1...OUT4	Meaning
Green	Output switched-on
Off	No input voltage connected or output active switched off via button
Green flashing (2 Hz)	Current/power budget exceeded The sum of the output currents exceeded the permissible total output current of the power supply. Outputs with low priority are switched off
Green flashing (4 Hz)	Pushbutton lock It is not possible to switch the output on or off via the button. Possible causes: <ul style="list-style-type: none"> ■ Pushbutton is locked by "external interface" or "button lock feature". ■ Interval between charge and switch-on cycles < 5 s (MOSFET protection). ■ Too high temperature at the output.
Orange	Pre-alarm: Output switched on, output current exceeds pre-alarm level, overload imminent.
Orange flashing (1 Hz)	Overcurrent at output due to overload The eFuse at the output has tripped. The output has switched off. <ul style="list-style-type: none"> ▶ Press button at the output (OUT1...OUT4) to restart the channel.
Orange flashing (2 Hz)	Installation faulty, cables or connected hardware at the outputs are not installed correctly. The output has switched off automatically. <ul style="list-style-type: none"> ▶ Switch off channel manually via button at output (OUT1...OUT4). Conditions: <ul style="list-style-type: none"> ■ PSU with NEC outputs: Difference between positive and negative current of the output has been >1 A for 6...6.5 s ■ PSU without NEC outputs: Connector negative wire overcurrent according to negative trip curve, or Output was contributing to negative overcurrent of another output.
Orange flashing (4 Hz)	Short-circuit at output The eFuse at the output has tripped. The output has switched off (output current at channel > 48 A). Possible causes: <ul style="list-style-type: none"> ■ Electrical short circuit ■ Too high loads connected ■ Plugging in a large capacitance during operation <ul style="list-style-type: none"> ▶ Press button at output (OUT1...OUT4). Outputs with eFuse try to restart automatically.
Orange/green flashing (2 Hz)	MOSFET overtemperature limit reached (125 °C) The output switches on again automatically when the temperature has dropped to max. 90 °C.
Red	Hardware Fault, MOSFET damaged (short circuit), PSU will be turned off. Cause: The power switch of a specific output is damaged. Replacing the power supply may be necessary.
Red flashing (1 Hz)	Hardware of the measuring circuit defective or values outside the permissible range. Replacement of the power supply unit may be necessary Possible causes: <ul style="list-style-type: none"> ■ The deviations of the internal output current sensors exceed the permissible limits. ■ Temperature sensor measurement out of range (-40 °C or +150 °C for more than 5 s).

9.3 Process data (cyclic IO-Link data)

The process data is sent cyclically to the IO-Link master. The device sends 2 bytes of process data.

Data	Resolution	Sub index	Data type	Length in bit	Bit offset	Description
Actual output total current	2 ⁻⁸ A/bit	1	UINT16	16	104	Total output current (actual value)
Actual output voltage 1	2 ⁻⁸ V/bit	2	UINT16	16	88	Actual Output Voltage
eFuse current ch1	2 ⁻⁸ A/bit	3	72	UINT16	16	Output current eFuse (actual value)
eFuse current ch2		4	56			
eFuse current ch3		5	40			
eFuse current ch4		6	24			
eFuse state ch1		10	16	BOOL	1	State of the eFuse: 0: inactive, cause: s. sub index 14...17 or sub index 18...21 1: active: eFuse switched on, output voltage available
eFuse state ch2		11	17			
eFuse state ch3		12	18			
eFuse state ch4		13	19			
eFuse ch1 — overload trip state		14	8	BOOL	1	Trip state of the eFuse in case of an overload: 0: OK 1: tripped, overload at output
eFuse ch2 — overload trip state		15	9			
eFuse ch3 — overload trip state		16	10			
eFuse ch4 — overload trip state		17	11			
eFuse ch1 — short-circuit state		18	0	BOOL	1	Trip state of the eFuse in case of as short-circuit: 0: OK 1: tripped, short-circuit at output
eFuse ch2 — short-circuit state		19	1			
eFuse ch3 — short-circuit state		20	2			
eFuse ch4 — short-circuit state		21	3			

9.4 Diagnostic and status messages (acyclic IO-Link data)

	Index Hex. (dec.)	Sub index	Data type	Bit offset	Resolution/ unit	Description/comment
EEPROM Status	0x40 (64)	0	UINT8	7...0		0: Ok 1: recoverable error detected 2: unrecoverable error
PSU events	0x41 (65)	0	UINT16			Parameter access via sub index 0 only
		1	BOOL	0		Bit 0: Output ok Output voltage > 90 % of the set output voltage, no output triggered
		2		1		Bit 1: DC-Warning: Output voltage dropped by more than 10 % below set output voltage
		3		2		Bit 2: additional power: PSU delivers additional power for more than 1 s
		4		3		Bit 3: Overtemperature CAP
		5		4		Bit 4: Overtemperature PSU: The temperature of the internal unit is too high
		6		5		Bit 5: Overload: Total output load higher than permitted
		7		6		Bit 6: High voltage input: AC input voltage exceeds operating range
		8		7		Bit 7: Low voltage input: AC input voltage falls below operating range
		9		8		Bit 8: Power supply failed: no internal connection from IO-Link transceiver to power supply
		10		9		Bit 9: Predictive maintenance power supply: Estimated remaining lifetime 10 %, power supply performance possibly limited due to component aging effects.
		11		10		Bit 10: 2-phase operation: One line of the 3-phase system is missing
14		13		Bit 13: PSU hardware failure: Internal hardware error in PSU		
Stress level	0x42 (66)	0	UINT8	0...7		Current load: 0: < 5 % 1: > 5 % 2: > 25 % 3: > 50 % 4: > 75 %

	Index Hex. (dec.)	Sub index	Data type	Bit offset	Resolution/ unit	Description/comment
Remaining endurance LED coded	0x43 (67)	0	UINT8	0...7		Endurance: 0: <10 % 1: > 10 % 2: > 25 % 3: > 50 % 4: > 75 %
Remaining Endurance	0x44 (68)	0	UINT8	0...7	%	Value range 10... 99 %
Temperature secondary inside	0x45 (69)	0	INT16	15...0	2 ⁻⁷ °C/bit	Value range: -5120...32640
Max. temperature secondary inside	0x46 (70)	0	INT16	15...0	2 ⁻⁷ °C/bit	Value range: -5120...32640
Temperature primary inside	0x47 (71)	0	INT16	15...0	2 ⁻⁷ °C/bit	Value range: -5120...32640
Max. temperature primary inside	0x48 (72)	0	INT16	15...0	2 ⁻⁷ °C/bit	Value range: -5120...32640
AC input voltage RMS	0x4E (78)	0	UINT16	15...0	2 ⁻⁴ V/bit	Actual input voltage RMS (phase-phase) Value range: 0...24000 (0...1500 V)
Actual output voltage	0x4F (79)	0	UINT16	15...0	2 ⁻⁸ V/bit	Value range: 0...12544 (0...49 V)
Converter average current	0x51 (81)	0	UINT16	15...0	2 ⁻⁸ A/bit	Value range: 0...12800 (0...50 V)
eFuse lout all channels	0x54 (84)	0	UINT16 (array)	63...0	2 ⁻⁸ A/bit	Output current eFuse Value range: 0:12800 (0 ...50 A)
eFuse lout Ch1		1	UINT16	63...48		
eFuse lout Ch2		2		47...32		
eFuse lout Ch3		3		31...16		
eFuse lout Ch4		4		15...0		
eFuse output status all channels	0x55 (85)	0	BOOL (array)			Parameter access via sub index 0 only
eFuse output status Ch 1			8-bit record	0		0: off 1: on
eFuse output status Ch 2				1		Bit 4...7: reserved
eFuse output status Ch 3				2		
eFuse output status Ch 4				3		
eFuse trip status Ch1	0x56 (86)	0	4-bit ENUM (array)	3...0		Parameter access via sub index 0 only
eFuse trip status Ch2				7...4		0: No trip
eFuse trip status Ch3				11...8		1: Overload trip
eFuse trip status Ch4				15...12		2: Short circuit trip
						3: Temperature trip
						4: Power budget trip
						5: Installation failure trip
						6: Sensor fault trip
						7: Fatal fault trip

Counter

	Index Hex. (dec.)	Sub index	Data type	Bit offset	Resolution/ unit	Description/comment
Operating hours (total)	0x49 (73)	0				Parameter access via sub index 0 only
■ Hours		1	UINT32	39...8	h	
■ Minutes		2	UINT8	7...0	min	Value range: 0...59
Transient VDE-0160 Counter overall	0x4A (74)	0	UINT32	31...0		Value range: 0...59
Transient VDE-0160 counter overall last 2 minutes	0x4B (75)	0	UINT32	31...0		Value range: 0...150000
Turn-on Counter	0x52 (82)	0	UINT32	31...0		Value range: 0...150000
Uptime since last turn-on	0x53 (83)	0				Parameter access via sub index 0 only
■ Hours		1	UINT32	39...8	h	
■ Hours		2	UINT8	7...0	min	Value range: 0...59
eFuse, number of startups all channels	0x57 (87)	0	UINT32 (array)	127...0		Value range: 0...150000
eFuse number of startups Ch1		1	UINT32	127...96		
eFuse number of startups Ch2		2		95...64		
eFuse number of startups Ch3		3		63...32		
eFuse number of startups Ch4		4		31...0		
eFuse, number of overcur- rents all channels	0x58 (88)	0	UINT16 (array)	63...0		Value range: 0...150000
eFuse number of overcurrents Ch1		1	UINT16	63...48		
eFuse number of overcurrents Ch2		2		47...32		
eFuse number of overcurrents Ch3		3		31...16		
eFuse number of overcurrents Ch4		4		15... 0		

Device status

	Index Hex. (dec.)	Sub index	Data type	Bit offset	Description/comment
Device status	0x24 (36)	0	UINT8	7...0	0: Device is operating properly 1: Maintenance-Required 2: Out-of-Specification 3: Functional-Check 4: Failure
Detailed Device Status	0x25 (37)	0	3-Byte string (array [5])	120	Shows up to 5 present events, access only via sub index 0 3 bytes per sub index :
Item [1]		1	3-Byte string	119...96	Byte 1: Event Qualifier
Item [2]		2		95...72	Byte 2, 3: Event code
Item [3]		3		71...48	
Item [4]		4		27...24	
Item [5]		5		23...0	

9.5 IO-Link Events

The device sends the IO-Link events below to the IO-Link master.

Event code	Event	Event-type	Description
0x1800	DC warning	Warning	The output voltage has dropped more than 10 % below the value for the set output voltage.
0x1801	Bonus Power	Notification	The output current is 5 % higher than the maximum value for longer than 3 s.
0x1802	Overload	Warning	The total output load is higher than permitted.
0x1803	High voltage input	Warning	The AC input voltage exceeds the operating range.
0x1804	Low voltage input	Warning	The AC input voltage is below the operating range.
0x1805	Power supply down	Warning	No internal connection from IO-Link transceiver to power supply
0x1806	Predictive maintenance — power supply	Warning	The estimated remaining lifetime has reached 10 %. Performance of PSU might be limited due to aging effects of components.
0x1807	2-phase operation	Warning	One leg of the 3-phase system is missing
0x1809	PSU setting changed via HMI	Notification	Settings were changed via the man-machine interface of the PSU.
0x1825	PSU hardware failure	Warning	Critical PSU hardware failure detected. PSU shut down.
0x1830	Converter 1 — pre-alarm output current	Warning	The total output current of the converter has exceeded the pre-alarm level for more.
0x1840	eFuse tripped ch1	Warning	The eFuse for the channel has tripped due to over-current.
0x1841	eFuse tripped ch 2	Warning	
0x1842	eFuse tripped ch 3	Warning	
0x1843	eFuse tripped ch 4	Warning	
0x1850	eFuse output current pre-alarm ch1	Notification	The output current of the eFuse at the channel has exceeded the pre-alarm level for more than 2 s.
0x1851	eFuse output current pre-alarm ch2	Notification	
0x1852	eFuse output current pre-alarm ch3	Notification	
0x1853	eFuse output current pre-alarm ch4	Notification	
0x4210	Permissible device temperature exceeded	Warning	The temperature in the device is too high.
0x6320	Parameter error	Error	The parameter settings of the device are invalid.

9.6 IO-Link error codes

Error code	Description	
0x8000	No details	Application error in device Service was denied by device, no detailed information available
0x8011	Index not available	
0x8012	Sub index not available	
0x8020	Service temporarily not available	No access to parameters possible, device does not allow access in current state
0x8021	Service temporarily not available, local control	No access to parameters possible, device in local operating mode, operation only via operator interface on device
0x2022	Service temporarily not available, device control	No access to parameters possible, device in remote operating mode, operation only via IO-Link
0x8023	Access denied	Access denied, index not writable
0x8030	Parameter value out of range	
0x8031	Parameter value above limit	
0x8032	Parameter value below limit	
0x8033	Parameter length overrun	Length of data to be written does not match the length defined for this parameter.
0x8034	Parameter length underrun	
0x8035	Function not available	Command not supported by the device
0x8036	Function temporarily unavailable	Command not supported by the device
0x8040	Interfering parameter	Invalid parameter set, a written single parameter value does not fit to other parameter settings
0x8041	Inconsistent parameter set	Parameters inconsistent, device plausibility check failed
0x8082	Application not ready	Device not ready, access denied

10 Maintenance

- ▶ Clean the devices at regular intervals with a damp cloth.

11 Repair

The device must not be repaired by the user. The device must be decommissioned if it is faulty. Observe our return acceptance conditions when returning the device to Turck.

11.1 Returning devices

Returns to Turck can only be accepted if the device has been equipped with a Decontamination declaration enclosed. The decontamination declaration can be downloaded from <https://www.turck.de/en/retoure-service-6079.php> and must be completely filled in, and affixed securely and weather-proof to the outside of the packaging.

12 Disposal



The devices must be disposed of correctly and must not be included in general household garbage.

13 Technical data

13.1 AC input

Technical data	
Input voltage	
■ Nominal range	3 AC, 380...480 VAC, $\pm 15\%$
■ Operating range AC input	3 \times 323...552 VAC
External fuse	B-6A, C-6A
Internal fuse	4 separate eFuses
Mains frequency	50...60 Hz $\pm 6\%$
Inrush current	Typ. 1.9 _{peak} /1.8 A _{peak} at 3 \times 400/480 VAC
Turn-on voltage	Typ. 3 \times 320 VAC, steady-state end value, s. fig.: Voltage range – input voltage AC
Turn-off voltage	Typ. 3 \times 300 VAC, steady-state end value, s. fig.: Voltage range – input voltage AC
Switch-on delay	Typ. 2 s, at 500 W, symmetrical phase voltages, s. fig.: Switch-on behavior
Rise time	Typ. 10 ms, at 500 W constant current load, 0 mF load, s. fig.: Switch-on behavior
	Typ. 12 ms, at 500 W constant current load, 12.5 mF load, s. fig.: Switch-on behavior
Input current	At 500 W, symmetrical phase voltages, s. fig.: Input current vs. output power (at 24 VDC output voltage)
	<ul style="list-style-type: none"> ■ 3 AC, 400 V Typ. 0.8 A ■ 3 AC, 480 V Typ. 0.66 A
Power factor	S. fig.: Power factor vs. output power (at 24 VDC output voltage)
	<ul style="list-style-type: none"> ■ 3 AC, 400 V typ. 0.94, at 500 W ■ 3 AC, 480 V typ. 0.95, at 500 W

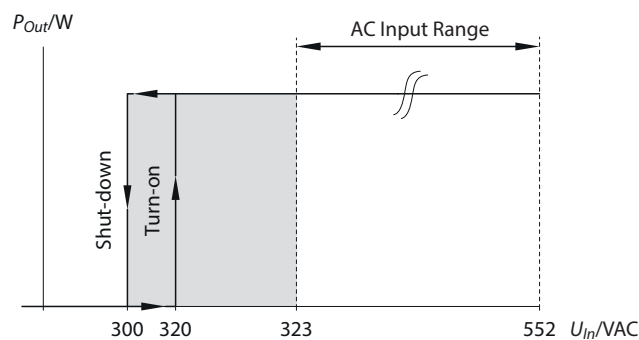

Fig. 13: Voltage range – input voltage AC

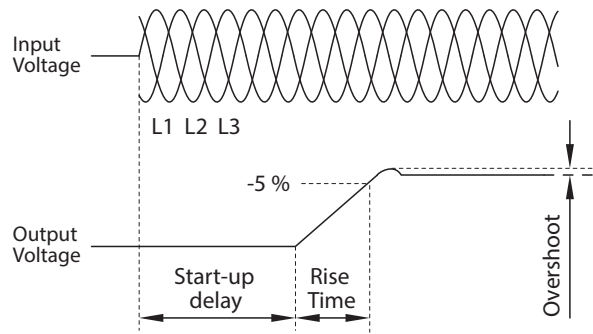

Fig. 14: Switch-on behavior

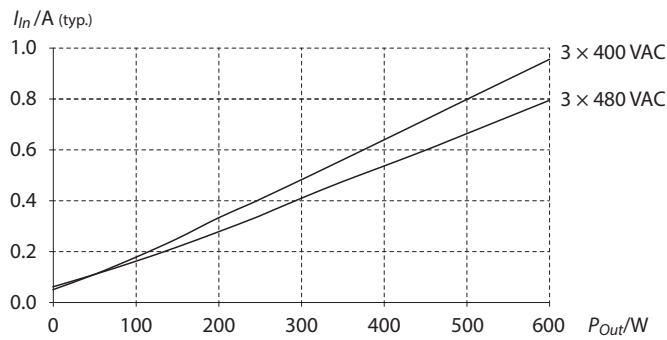

Fig. 15: Input current vs. output power (at 24 VDC output voltage)

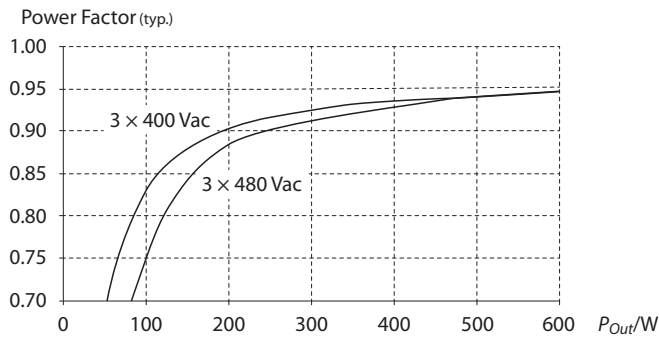

Fig. 16: Power factor vs. output power (at 24 VDC output voltage)

13.2 DC output

Technical data		
Number of outputs	4	
Output voltage		
■ Nominal	24 VDC	Default-setting: 24.5 V
■ Adjustment range	24... 28 V	Settable in steps: 24 V, 24,5 V, 25 V, 25.5 V, 26 V, 26.5 V, 27 V and 28 V
Factory setting	Typ. 24.5 V, $\pm 0,2\%$, at nominal load	
Line regulation	Max. 10 mV	Linear voltage regulation
Load regulation	Typ. 100 mV	0...600 W output load, static value
Ripple and noise voltage	Max. 100 mV _{pp}	Bandwidth 20 Hz...20 Mhz, 50 Ω
Output current	Max. 12 A per output, s. fig.: Trip curve diagram (max. 12 A)	
Output power 24 V...28 V, continuous at ambient temperature:	■ At 45 °C ■ At 55 °C ■ At 70 °C	600 W 500 W 350 W
Linear derating between +45 °C and +70 °C, s. fig.: Derating output power vs. ambient temperature		
Total output power, short-term, up to 5 s, at ambient temperature:	■ Up to 55 °C ■ Up to 70 °C	1000 W 700 W
Overload behavior	S. fig.: Trip curve diagram (max. 12 A)	
Internal output capacitance	Typ. 12500 μ F	For all outputs in total
Parallel use	No	Do not connect outputs or devices in parallel.
Back-feeding loads	Max. 35 V/4 J	For all outputs together, even when switched off

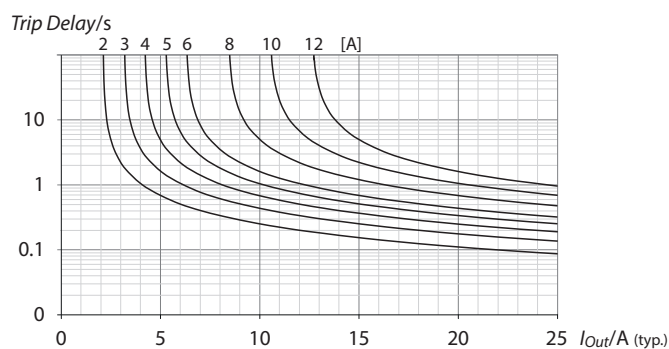

Fig. 17: Trip curve diagram (max. 12 A)

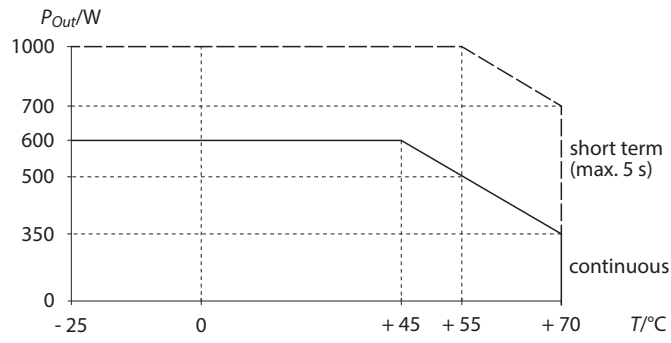

Fig. 18: Derating – output power vs. ambient temperature

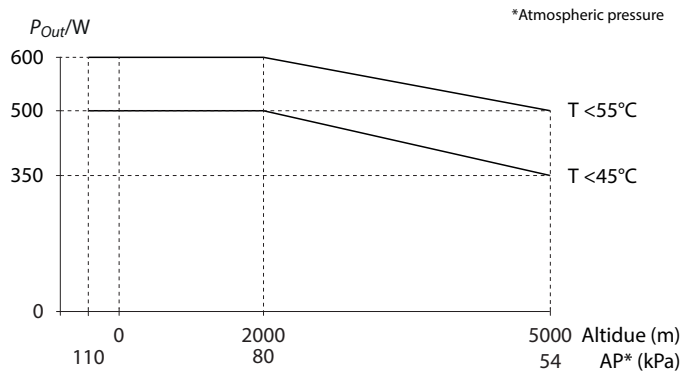

Fig. 19: Derating – output power vs. altitude

13.3 Efficiency and power losses

	3 AC, 400 V	3 AC, 480 V	
Efficiency	Typ. 95.8 %	Typ. 95.6 %	At 24 VDC, 500 W
Power losses	Typ. 2.5 W	Typ. 2.5 W	At 24 VDC, 0 W (no load)
	Typ. 12 W	Typ. 13 W	At 24 VDC, 250 W (half load)
	Typ. 22 W	Typ. 23 W	At 24 VDC, 500 W (full load)

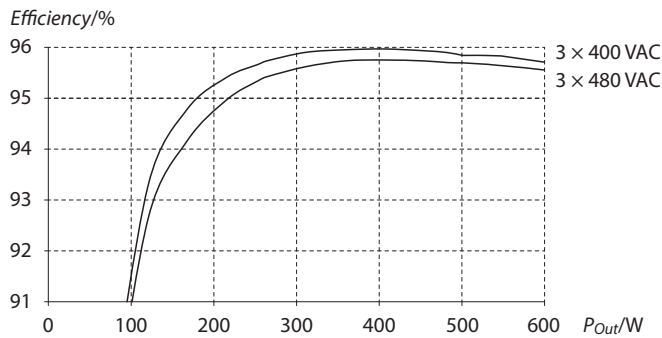

Fig. 20: Power factor vs. output power at 24 VDC (typ.)

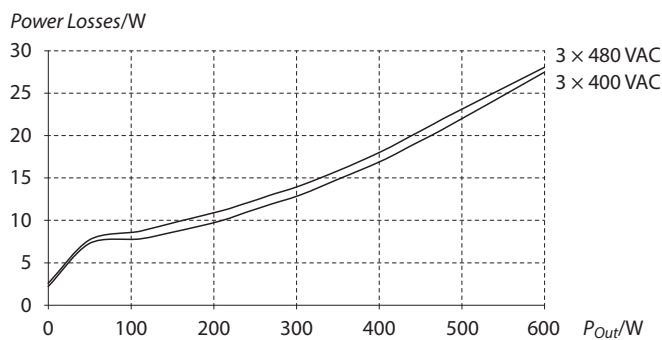

Fig. 21: Power losses vs. output power at 24 VDC (typ.)

13.4 IO-Link interface

Technical data	
Connector	M12 male connector, 5-pole, A-coded
IO-Link version	V1.1
Baud rate	COM3 (230.4 kBaud)
Cycle Time	2 ms
SIO Mode	Supported
Process data length	23 byte

13.5 General technical data

Technical data		
Calculated lifetime expectancy		
	3 AC, 400 V	3 AC, 480 V
■ At 24 V, 500 W, 40 °C	43000 h	37000 h
■ At 24 V, 250 W, 40 °C	177000 h	168000 h
■ At 24 V, 500 W, 25 °C	135000 h	119000 h
■ At 24 V, 250 W, 25 °C	466000 h	416000 h
MTBF		
MTBF SN 29500, IEC 61709	3 AC, 400 V	3 AC, 480 V
■ At 24 V, 500 W, 40 °C	253000 h	233000 h
■ At 24 V, 500 W, 25 °C	461000 h	427000 h
MTBF MIL HDBK 217F		
■ At 24 V, 500 W and 40 °C, Ground Benign GB40	98000 h	93000 h
■ At 24 V, 500 W and 25 °C, Ground Benign GB25	144000 h	138000 h
■ At 24V, 500 W and 40°C, Ground Fixed GF40	25000 h	24000 h
■ At 24V, 500 W and 25 °C, Ground Fixed GF25	33000 h	32000 h
EMC	According to EN 1000-6-1, EN 61000-6-2, EN 61000-6-3, EN 61000-6-4, EN 61000-3-2 and EN 61000-3-3	
Ambient conditions		
Operating temperature	-25°C...+70 °C (-13°F...158 °F)	Operational temperature is the same as the ambient or surrounding temperature and is defined as the air temperature 2 cm below the unit.
Storage temperature	-40°C...+85 °C (-40°F...185 °F)	For storage and transportation
Output derating	10 W/°C	Between +45 °C and +70 °C (113 °F and 140 °F)
33 W/1000 m or 5 °C/1000 m	For altitudes >2000 m (6560 ft), s. fig.: Output power vs. ambient temperature [▶ 35]	
The derating is not hardware controlled. Observe reduced current limits to avoid overloading the device.		
Humidity	5...95 % r.h.	According to IEC 60068-2-30
Atmospheric pressure	54...110 kPa	S. fig.: Output power vs. ambient temperature [▶ 35]
Altitude	Max. 5000 m (16 400 ft)	S. fig.: Output power vs. altitude [▶ 35]

Technical data		
Overvoltage category	III	According to IEC 60664-1 For TN, TT mains systems with earthed neutral and IT star mains systems with insulation monitoring for altitudes up to 2000 m
	II	For TN, TT mains systems with earthed neutral and IT star mains systems with insulation monitoring for altitudes between 2000 m and 5000 m For TN, TT, IT Delta mains systems or IT star mains systems without insulation monitoring for altitudes up to 2000 m
Degree of pollution	3	According to IEC 62477-1, not conductive
Vibration sinusoidal	2-17.8 Hz: ± 1.6 mm; 17.8-500 Hz: 2g 2 hours per axis	According to IEC 60068-2-6
Shock	30 g 6 ms, 20 g: 11 ms 3 bumps per direction, 18 bumps in total	According to IEC 60068-2-27
Degree of pollution	3	According to IEC 62477-1, not conductive
Vibration sinusoidal	2-17.8 Hz: ± 1.6 mm; 17.8-500 Hz: 2g 2 hours per axis	According to IEC 60068-2-6
Shock	30 g 6 ms, 20 g: 11 ms 3 bumps per direction, 18 bumps in total	According to IEC 60068-2-27
LABS compatibility	Yes	
Audible noise	Some audible noise may be emitted from the power supply during no load, overload or short circuit.	
Safety and protection features		
Isolation resistance		
■ Input to output ■ Input to PE	Min. 500 M Ω	As delivered, measured with 500 VDC
PE resistance	Max. 0.1 Ω	Resistance between PE terminal and the housing
Input/Output separation	PELV	IEC/EN/UL 61010-2-201, IEC/EN 62368-1, IEC/EN 60950-1
Output over-voltage protection	Typ. 31.8 VDC Max. 32.5 VDC	In case of an internal defect, a redundant circuit limits the maximum output voltage. The output shuts down and automatically attempts to restart.
Protection class	According to IEC 61140, PE connection required	

Technical data		
Degree of protection	IP65/IP67	According to EN/IEC 60529
Overtemperature protection	Yes, internal	Output shut down with automatic restart.
Input transient protection	MOV (Metal Oxide Varistor)	
Internal input fuse		Not user replaceable, slow-blow high-breaking capacity fuse
Touch current (leakage current)	Max. 0.45/ 1.5 mA	At 3 × 480 AC, 60 Hz, TN-,TT-mains/IT-mains, lower currents at lower voltages and frequencies.
Installing	4 × M4 screw	Standard orientation: vertical, connection level downwards with two screws each at the upper and lower mounting holes Other mounting orientations: reduce the output current, derating: max. output power at max. ambient temperature (s. fig.: Derating – standard mounting orientation): ■ max. 500 W at max. 45 °C ■ max. 350 W at max. 60 °C

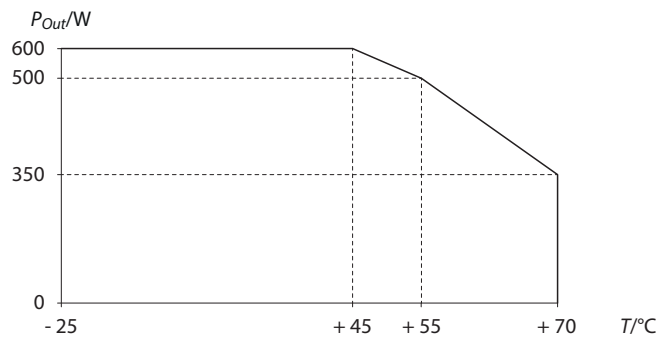

Fig. 22: Derating – standard mounting orientation

14 Turck subsidiaries — contact information

Germany	Hans Turck GmbH & Co. KG Witzlebenstraße 7, 45472 Mülheim an der Ruhr www.turck.de
Australia	Turck Australia Pty Ltd Building 4, 19-25 Duerdin Street, Notting Hill, 3168 Victoria www.turck.com.au
Austria	Turck GmbH Graumanngasse 7/A5-1, A-1150 Wien www.turck.at
Belgium	TURCK MULTIPROX Lion d'Orweg 12, B-9300 Aalst www.multiprox.be
Brazil	Turck do Brasil Automação Ltda. Rua Anjo Custódio Nr. 42, Jardim Anália Franco, CEP 03358-040 São Paulo www.turck.com.br
Canada	Turck Canada Inc. 140 Duffield Drive, CDN-Markham, Ontario L6G 1B5 www.turck.ca
China	Turck (Tianjin) Sensor Co. Ltd. 18,4th Xinghuazhi Road, Xiqing Economic Development Area, 300381 Tianjin www.turck.com.cn
Czech Republic	TURCK s.r.o. Na Brne 2065, CZ-500 06 Hradec Králové www.turck.cz
France	TURCK BANNER S.A.S. 11 rue de Courtalin Bat C, Magny Le Hongre, F-77703 MARNE LA VALLEE Cedex 4 www.turckbanner.fr
Great Britain	TURCK BANNER LIMITED Blenheim House, Hurricane Way, GB-SS11 8YT Wickford, Essex www.turckbanner.co.uk
Hungary	TURCK Hungary kft. Árpád fejedelem útja 26-28., Óbuda Gate, 2. em., H-1023 Budapest www.turck.hu
India	TURCK India Automation Pvt. Ltd. 401-403 Aurum Avenue, Survey. No 109 /4, Near Cummins Complex, Baner-Balewadi Link Rd., 411045 Pune - Maharashtra www.turck.co.in
Italy	TURCK BANNER S.R.L. Via San Domenico 5, IT-20008 Bareggio (MI) www.turckbanner.it

Japan	TURCK Japan Corporation ISM Akihabara 1F, 1-24-2, Taito, Taito-ku, 110-0016 Tokyo www.turck.jp
Korea	Turck Korea Co, Ltd. B-509 Gwangmyeong Technopark, 60 Haan-ro, Gwangmyeong-si, 14322 Gyeonggi-Do www.turck.kr
Malaysia	Turck Banner Malaysia Sdn Bhd Unit A-23A-08, Tower A, Pinnacle Petaling Jaya, Jalan Utara C, 46200 Petaling Jaya Selangor www.turckbanner.my
Mexico	Turck Comercial, S. de RL de CV Blvd. Campestre No. 100, Parque Industrial SERVER, C.P. 25350 Arteaga, Coahuila www.turck.com.mx
Netherlands	Turck B. V. Ruiterlaan 7, NL-8019 BN Zwolle www.turck.nl
Poland	TURCK sp.z.o.o. Wroclawska 115, PL-45-836 Opole www.turck.pl
Romania	Turck Automation Romania SRL Str. Siriului nr. 6-8, Sector 1, RO-014354 Bucuresti www.turck.ro
Russian Federation	TURCK RUS OOO 2-nd Pryadilnaya Street, 1, 105037 Moscow www.turck.ru
Sweden	Turck Sweden Office Fabriksstråket 9, 433 76 Jonsered www.turck.se
Singapore	TURCK BANNER Singapore Pte. Ltd. 25 International Business Park, #04-75/77 (West Wing) German Centre, 609916 Singapore www.turckbanner.sg
South Africa	Turck Banner (Pty) Ltd Boeing Road East, Bedfordview, ZA-2007 Johannesburg www.turckbanner.co.za
Turkey	Turck Otomasyon Ticaret Limited Sirketi Inönü mah. Kayisdagi c., Yesil Konak Evleri No: 178, A Blok D:4, 34755 Kadiköy/ Istanbul www.turck.com.tr
USA	Turck Inc. 3000 Campus Drive, USA-MN 55441 Minneapolis www.turck.us

TURCK

Over 30 subsidiaries and
60 representations worldwide!

100032475 | 2023/01



www.turck.com