

# WKCV4.4T-P7X2-20/TEL 执行器/传感器电缆，PVC – Connection cable

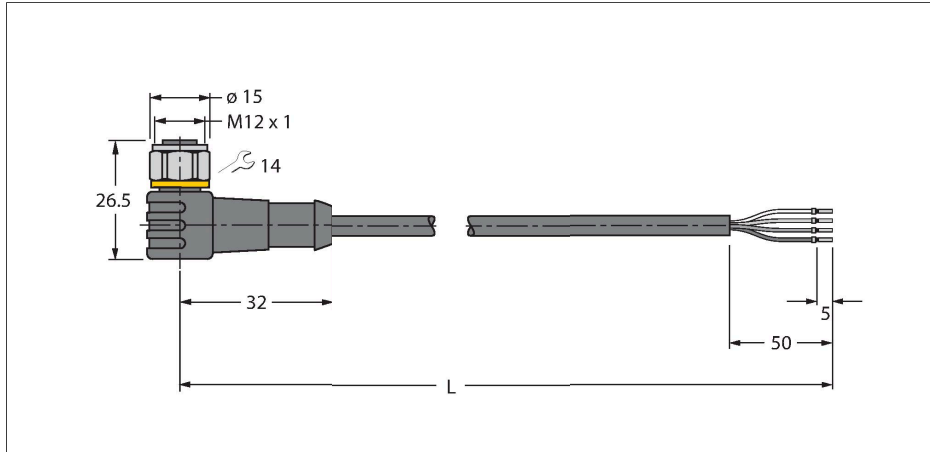

## 特点



- Female M12, angled, 4-pin
- With 2-color LED (PNP, yellow, green)
- Stainless steel coupling nut/screw
- 护套材质：PVC
- 护套颜色：黑色
- 耐化学品、耐油
- 具有阻燃性
- 耐酸性和碱性溶液
- 抗微生物，抗水解
- 不含LABS
- 防护等级：IP67、IP69K
- 电缆长度：20 m

## 导线横截面

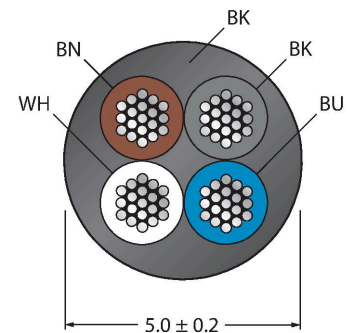

## 触点分配

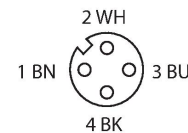

## 电路图

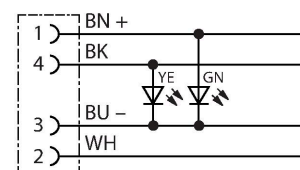

## 技术数据

型号	WKCV4.4T-P7X2-20/TEL
货号	6626159
接插件A	孔头, M12 × 1, 弯角, A-coded
针脚数量	4
触点	铜, CuZn, 镀金
触点夹紧	塑料, TPU, 黑色
拧接把手	塑料, TPU, 半透明
连接螺母/螺钉	不锈钢, V4A
Seal	塑料, FPM/FKM
Display operating voltage	LED, 绿
Display switch state	LED, 黄
机械寿命	> 100 插接次数
污染程度	3
保护类型	IP67, IP69K, 仅在拧紧状态下
电缆	
线缆直径	Ø 5 mm ±0.20
线缆长度	20 m
线缆护套	PVC, 黑色
导线绝缘性	PVC
线芯横截面	4 x 0.34 mm <sup>2</sup>
绞合线, 布置	42 x 0.1 mm
线圈颜色	BN, WH, BU, BK
电气性能@20°C	
额定电压	30 V <sub>DC</sub>
测试电压	2000 V
电流	4 A
绝缘阻抗	> 30.5 MΩ/km

## 技术数据

正向电阻	最大值 57 Ω/km
<b>机械和化学性能</b>	
弯曲半径 (固定式安装)	≥ 5 x Ø
弯曲半径 (柔性)	≥ 10 x Ø
固定	-40 °C...+105 °C
的区域	-5 °C...+80 °C
认证	cULus

## 附件

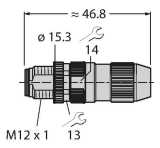
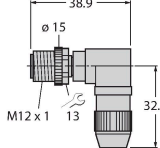
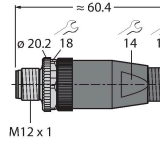
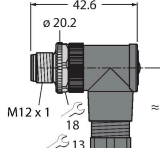
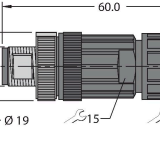
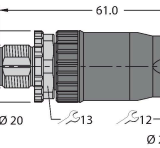
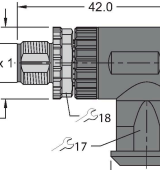
<p><b>HAS8141-0</b></p> 	<p><b>6905406</b></p> <p>现场可接线公头连接器, M12 × 1, 直型, 4针, 绝缘刺穿连接, 电缆引线4.0-5.1 mm, 线芯横截面/终端容量0.14-0.34 mm<sup>2</sup>, 塑料外壳, 金属螺母</p>	<p><b>HAS8241-0</b></p> 	<p><b>6905400</b></p> <p>现场可接线公头连接器, M12 × 1, 弯角型, 4针, 绝缘刺穿连接, 电缆引线4.0-5.1 mm, 线芯横截面/终端容量0.14-0.34 mm<sup>2</sup>, 塑料外壳, 金属螺母</p>
<p><b>BS8141-0</b></p> 	<p><b>69010</b></p> <p>现场可接线公头连接器, M12 × 1, 直型, 4针, 螺旋式接线柱连接, 电缆穿墙护孔4.0至6.0 mm, 线芯横截面/接线柱可容面积0.14至0.75 mm<sup>2</sup>, 塑料外壳, 金属固定螺钉</p>	<p><b>BS8241-0</b></p> 	<p><b>69011</b></p> <p>现场可接线接插件, M12 × 1, 弯式, 4针, 螺旋式接线柱, 电缆引线4.0至6.0 mm, 线芯横截面/接线柱可容面积0.14至0.75 mm<sup>2</sup>, 塑料外壳, 金属固定螺钉</p>
<p><b>FW-ERSPM0426-SA-P-0408</b></p> 	<p><b>100002048</b></p> <p>现场可接线公头接插件, M12 × 1, 直型, 4针, 推入式连接, 电缆引线4.0至8.0 mm, 线芯横截面/接线柱可容面积0.14至0.75 mm<sup>2</sup>, 塑料外壳, 金属固定螺钉</p>	<p><b>FW-ERSPM0416-SA-S-0408</b></p> 	<p><b>100002288</b></p> <p>现场可接线公头连接器, M12 × 1, 直型, 4针, 螺旋式接线柱连接, 电缆引线4.0至8.0 mm, 线芯横截面/接线柱可容面积0.25至1.5 mm<sup>2</sup>, 塑料外壳, 金属固定螺钉</p>
<p><b>FW-EWSPM0416-SA-S-0408</b></p> 	<p><b>100002290</b></p> <p>现场可接线公头接插件, M12 × 1, 弯角型, 4针, 螺旋式接线柱连接, 电缆引线4.0至8.0 mm, 线芯横截面/接线柱可容面积0.25至1.5 mm<sup>2</sup>, 塑料外壳, 金属固定螺钉</p>	<p><b>TORQUE-WRENCH-SET-AS</b> <b>6936170</b></p> <p>扭矩扳手套装; 处理可调扭矩0.4-1.0 Nm, 用于M8 (SW9)的扭矩扳手, 用于M12 (SW 14)的叉形扳手</p>	

BLANK-LABEL-FOR-CORDSETS-TEL-TXL 6936206

TEL 和 TXL 线缆标签，长度：18 mm，高度：4 mm，材料：聚碳酸酯 (PC)，颜色：白色，不含卤素，阻燃

