

RI90P1-QR20-LU4X2

Miniature Encoder – With Analog Output

Premium Line

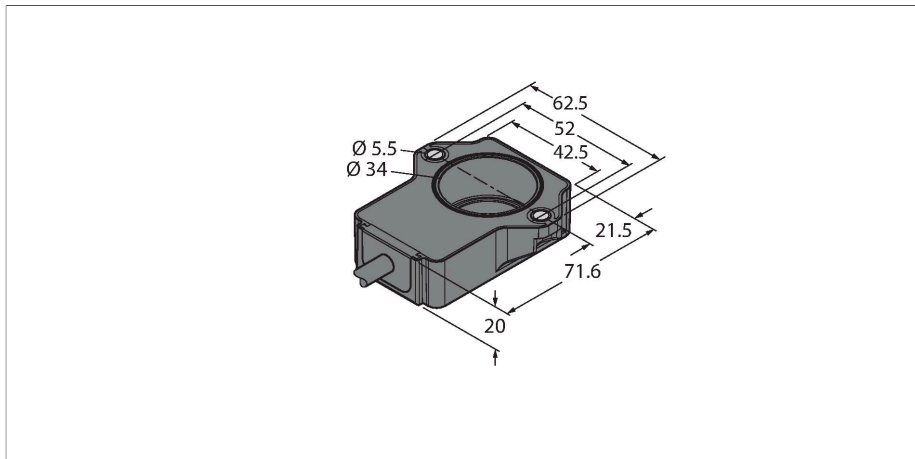

Technical data

Type	RI90P1-QR20-LU4X2
ID	100000190
Measuring principle	Inductive
General data	
Starting torque shaft load (radial / axial)	Not applicable because of contactless measuring principle
Resolution	0.09°/12 bit
Measuring range	-45...45 °
Nominal distance	1 mm
Repeat accuracy	≤ 0.1 % of full scale
Linearity deviation	≤ 1.25 % f.s.
Temperature drift	≤ ± 0.01 %/K
Output type	Absolute singleturn
Electrical data	
Operating voltage	8...30 VDC
Residual ripple	≤ 10 % U _{ss}
Isolation test voltage	≤ 0.5 kV
Short-circuit protection	yes
Wire breakage/Reverse polarity protection	no / yes (voltage supply)
Output function	3-wire, Analog output
Voltage output	0.5...4.5 V
Diagnostic	Positioning element not detected: Output signal 5 V
Load resistance voltage output	≥ 4.7 kΩ
Sample rate	800 Hz
Load-dump protection (DIN ISO 7637-2)	Severity degree IV/Level 4

Features

- Rectangular, plastic
- Compact and robust housing
- Versatile mounting possibilities
- Positioning element P1-RI-QR20 included in delivery
- For vehicle board nets, 12 V and 24 V
- Increased interference immunity 100 V/m following the e1 type approval
- Protection against conducted interference acc. to DIN ISO 7637-2 (SAE J 113-11)
- Extended temperature range
- High protection class IP68/IP69K
- Protection against salt spray and rapid temperature changes
- Measuring range displayed via LED
- Immune to electromagnetic interference
- Resolution: 0.09°
- 3-wire, 8...30 VDC
- Analog output 0.5...4.5 V
- Output 5 V (typ.) where there is no RLC coupling

Wiring diagram

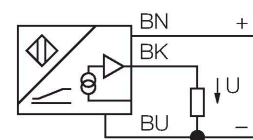

Functional principle

These sensors are extremely reliable even under the most extreme environmental conditions. Their extremely robust design meets the requirements for the IP68 and IP69K protection ratings.

Technical data

Current consumption	< 100 mA
Mechanical data	
Design	Rectangular, QR20
Dimensions	71.6 x 62.6 x 20 mm
Flange type	Flange without mounting element
Shaft Type	Blind hole shaft
Shaft diameter D [mm]	6 6.35
Housing material	Plastic, Ultem
Electrical connection	Cable
Cable quality	Ø 5.2 mm, Lif32Y32Y, TPE, 2 m
Core cross-section	3 x 0.5 mm ²
Environmental conditions	
Ambient temperature	-40...+85 °C
Storage temperature	-40...+125 °C
Temperature changes (EN60068-2-14)	-40... +85 °C; 20 cycles
Vibration resistance	55 Hz (1 mm)
Vibration resistance (EN 60068-2-6)	20 g; 10...3000 Hz; 50 cycles; 3 axes
Shock resistance (EN 60068-2-27)	100 g; 11 ms ½ sine; 3 × each; 3 axes
Continuous shock resistance (EN 60068-2-29)	40 g; 6 ms ½ sine; 4000 × each; 3 axes
Salt spray test (EN 60068-2-52)	Severity degree 5 (4 test cycles)
Protection class	IP68 IP69K
MTTF	423 years acc. to SN 29500 (Ed. 99) 40 °C
Power-on indication	LED, Green
Measuring range display	multifunction LED, green green flashing
Included in delivery	Positioning element P1-RI-QR20; for technical details see data sheet

Thanks to their excellent resistance to constant shocks and thermal shock resistance, they are the ideal choice for mobile applications, such as road construction vehicles and agricultural machinery.

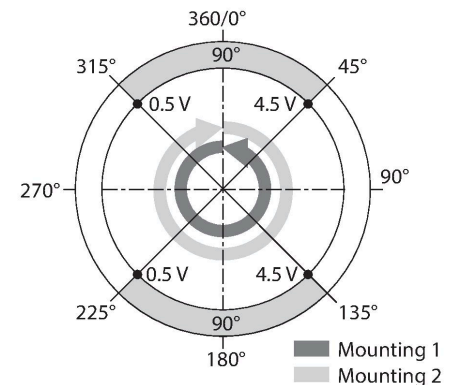

Mounting instructions

Mounting instructions/Description

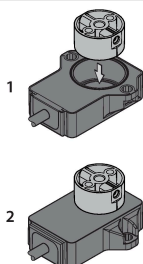

There are two different mounting options. One option is to position the positioning element above the sensor housing. However, it can also be mounted so that the sensor housing completely encloses the positioning element.

LED function
 Operating voltage
 Green: Power on
 Displayed measuring range
 Green: Positioning element is in the detection range
 Green flashing: Positioning element is within the measuring range, low signal intensity (e.g. distance too large)

Off: Positioning element is outside the detection range

Inductive measuring principle provides more safety

Due to the measuring principle, which is based on the functional principle of an RLC coupling, the sensor operates absolutely wear-free and is immune to magnetized ironware and other interferences. The amplitude of the signal can be changed by metal parts, which in turn affects the accuracy.

Owing to the differential analysis, the output signal remains almost unchanged, even if the position of the positioning element deviates from the ideal axis of rotation. The distance between the sensor and the positioning element can be up to 5 mm, whereby the nominal distance is 1 mm.

Accessories

P1-RI-QR20

1593041

Positioning element for encoder RI-QR20, for Ø 6 mm shafts

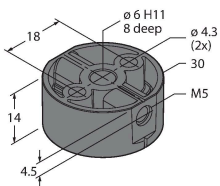

P2-RI-QR20

1593042

Positioning element for encoder RI-QR20, for Ø 6.35 mm shafts

