

RU50U-S18-AP8X

Ultrasonic Sensor – Diffuse Mode Sensor

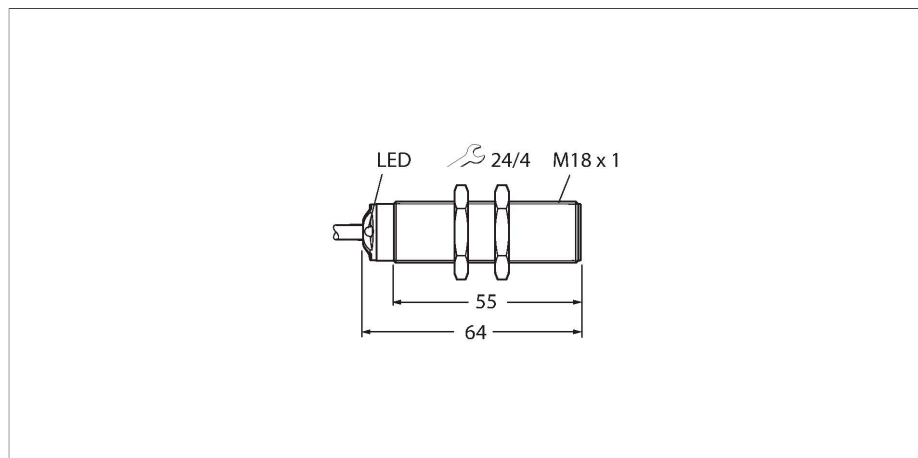

Features

- Smooth sonic transducer face
- Cylindrical housing S18, potted
- Connection via cable, 2 m
- Teach range adjustable via adapter
- Temperature compensation
- Blind zone: 5 cm
- Range: 50 cm
- Aperture angle of sonic cone: $\pm 20^\circ$
- PNP switching output, NO contact
- Switching range adjustable

Wiring diagram

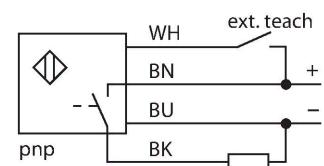

Functional principle

Ultrasonic sensors capture a multitude of objects contactlessly and wear-free with ultrasonic waves. It does not matter whether the object is transparent or opaque, metallic or non-metallic, firm, liquid or powdery. Even environmental conditions such as spray, dust or rain hardly affect their function. The sonic cone diagram indicates the detection range of the sensor. In accordance with standard EN 60947-5-2, quadratic targets in a range of sizes (20 × 20 mm, 100 × 100 mm) and a round rod with a diameter of 27 mm are used. Important: The detection ranges for other targets may differ from those for standard targets due to the different reflection properties and geometries.

Sonic Cone

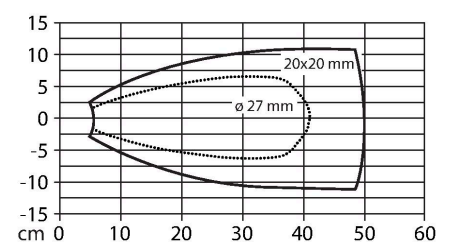

Technical data

Type	RU50U-S18-AP8X
ID no.	100000394
Ultrasonic data	
Function	Proximity switch
Range	50...500 mm
Resolution	0.2 mm
Minimum switching range	5 mm
Ultrasound frequency	300 kHz
Repeat accuracy	$\leq 0.15\%$ of full scale
Temperature drift	$\pm 1.5\%$ of full scale
Linearity error	$\leq \pm 0.5\%$
Edge lengths of the nominal actuator	20 mm
Approach speed	≤ 5 m/s
Pass speed	≤ 3 m/s
Electrical data	
Operating voltage	15...30 VDC
DC rated operational current	≤ 150 mA
No-load current	≤ 50 mA
Residual current	≤ 0.1 mA
Response time typical	< 65 ms
Readiness delay	≤ 300 ms
Output function	NO contact, PNP
Output 1	Switching output
Switching frequency	≤ 9.6 Hz
Hysteresis	≤ 5 mm
Voltage drop at I_o	≤ 2.5 V

Technical data

Short-circuit protection	yes / Cyclic
Reverse polarity protection	yes
Wire breakage protection	yes
Setting option	Remote Teach
Mechanical data	
Design	Threaded barrel, S18
Radiation direction	straight
Dimensions	Ø 18 x 64 mm
Housing material	Plastic, LCP, Yellow
End cap	Plastic, EPTR, black
Transducer material	Plastic, Epoxyd resin and PU foam
Electrical connection	Cable, 4-wire, 2 m
Ambient temperature	-20...+50 °C
Storage temperature	-40...+80 °C
Protection class	IP67
Switching state	LED, Yellow
Tests/approvals	
MTTF	293 years acc. to SN 29500 (Ed. 99) 40 °C
Declaration of conformity EN ISO/IEC	EN 60947-5-2
Vibration resistance	IEC 60068-2-6

Mounting instructions

Mounting instructions/Description

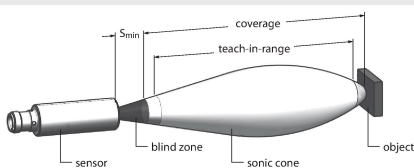

Setting the switching point

The ultrasonic sensor features a switching output with a teachable switching point. The yellow LED indicates whether the object is within the switching range of the sensor.

One switching point is taught. This must be within the detection range. In this operating mode the background is suppressed.

Simple Teach-In

Place object at the end of the switching range
Pin 2/seal the white core against Ub for 2...7 s
• Return to normal operating mode after 17 s or more.

After a successful teach-in, the yellow LED flashes 3 times and the sensor runs automatically in normal operating mode.

LED response

In normal operating mode, the LED signals the switching state of the sensor.

Accessories

BSS-18

6901320

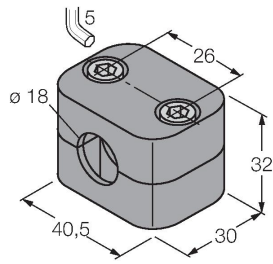

Mounting clamp for smooth and threaded barrel sensors; material: Polypropylene

MW-18

6945004

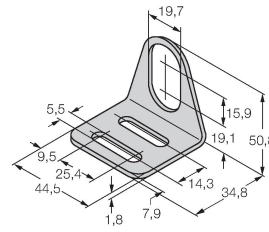

Mounting bracket for threaded barrel sensors; material: Stainless steel A2 1.4301 (AISI 304)

VB2-SP1

A3501-29

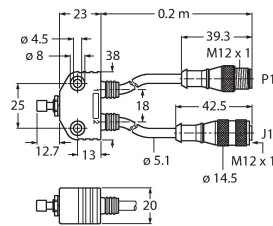

Teach adapter