

I/O Hub for Connection of Digital Signals to IO-Link Master

16 Universal Digital Channels, PNP

TBIL-M1-16DXP-B

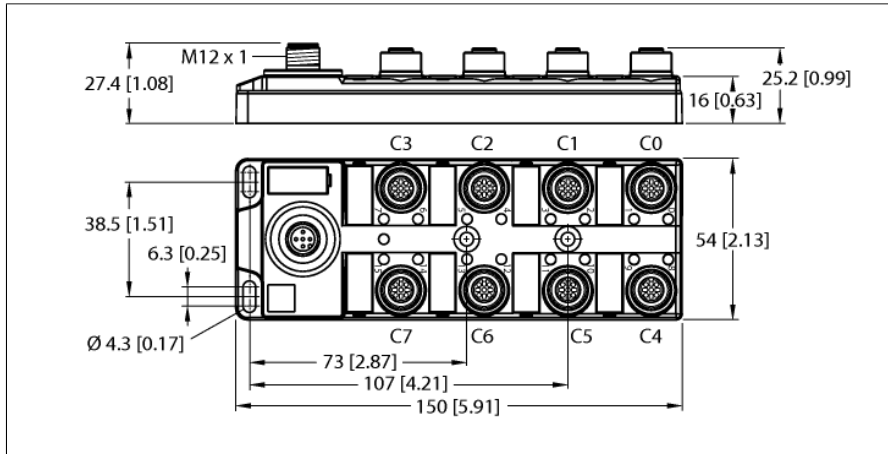

Type	TBIL-M1-16DXP-B
ID	100000881
Supply	
Supply voltage	24 VDC
Admissible range	18...30 VDC (UL rating 20.4...28.8 VDC) V1: 4 A V2: 4 A V1+V2: max. 4 A up to 70 °C V1+V2 max. 5.4 A up to 55 °C
Operating current	120 mA
Sensor/actuator supply	Class A supply C0...C3 from V1 Short-circuit protected, 1.8 A per connector
Sensor/actuator supply	Class B supply C4...C7 from V2 Short-circuit protected, 1.8 A per connector
Electrical isolation	Potential isolation of V1 and V2 voltage group Voltage proof up 500 VDC
Fault exclusion	Yes, acc. to EN ISO 13849-2, appendix D.2
Digital inputs	
Number of channels	16
Connectivity inputs	M12
Type of input diagnostics	Channel diagnostics
Low-level signal voltage	-3...5 VDC (EN 61131-2, type 1 and 3)
High level signal voltage	11...30 VDC (EN 61131-2, type 1 and 3)
Input delay	0.010 ms
Max. input current	15 mA
Digital outputs	
Number of channels	16
Connectivity outputs	M12
Output type	PNP
Type of output diagnostics	Channel diagnostics
Output delay	0.35 ms
Load type	Resistive, inductive, lamp load
Short-circuit protection	yes
Electrical isolation	500 VDC

- IO-Link V1.1 Class B
- Glass fiber reinforced housing
- Shock and vibration tested
- Fully potted module electronics
- Protection classes IP65, IP67, IP69K
- Galvanically isolated class B supply supports passive safety
- 2 universal digital channels per slot
- I&M data sets support installation and maintenance
- IO-Link diagnostics for short circuit and supply voltage

IO-Link	
Connectivity IO-Link	1 × M12
IO-Link specification	V 1.1
IO-Link port type	Class A and Class B
Frame type	2,6
Transmission rate	COM 2/38.4 kbps
Programming	FDT/DTM
Standard/Directive conformity	
Vibration test	Acc. to IEC 60068-2-6
Shock test	acc. to IEC 60068-2-27
Approvals and certificates	CE, cULus, Class I Div.2
UL Certificate	cULus LISTED 21 W2, Encl.type 1 IND.CONT.EQ.
General Information	
Dimensions (W x L x H)	54 x 150 x 27.4 mm
Ambient temperature	-40...+70 °C
Storage temperature	-40...+85 °C
Altitude	Max. 5000 m
Protection class	IP65 IP67 IP69K
MTTF	79 years acc. to SN 29500 (Ed. 99) 20 °C
Housing material	PA6-GF30
Housing color	Black
Mounting	4 mounting holes, Ø 4.3 mm

Pin configuration and wiring diagrams

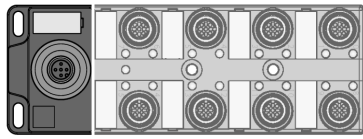

Accessories

Extension cable (example): □RK 4.5T-2-RS 4.5T□ Ident-No. U2187-1□ or □RKC4.5T-2-RSC4.5T/TEL□ ID No. 6625212

IO-Link M12 x 1

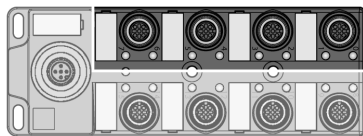
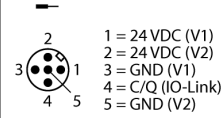

Accessories

Extension cable (example): RK 4.4T-2-RS 4.4T ident-no. U2445 or RKC4.4T-2-RSC4.4T/TEL ident-no. 6625208

M12 × 1 I/O Port

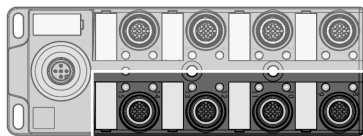
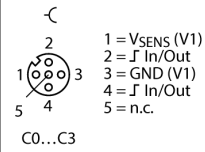

Accessories

Extension cable (example): RK 4.4T-2-RS 4.4T ident-no. U2445 or RKC4.4T-2-RSC4.4T/TEL ident-no. 6625208

M12 × 1 I/O Port

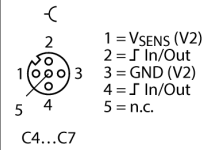

Module LED status

LED Display	Color	Status	Description
IO-Link	Green	OFF	Power off
		Flashing	IO-Link communication OK, valid process data is being sent or received
	Red	ON	IO-Link communication or module error
		Flashing	IO-Link communication OK, invalid process data or diagnosis enabled

I/O LED Status

LED Display	Color	Status	Description
C0...C7	Green	ON	Input or output active
0...15	Red	ON	Output active with overload/short circuit
		Flashing	Power overload at the corresponding port. Both port LEDs are flashing.
		OFF	Input or output inactive

C... = port no., 0...15 = signal LED (even = pin 4, uneven = pin 2)

Process data

INPUT	BYTE	Bit 7	Bit 6	Bit 5	Bit 4	Bit 3	Bit 2	Bit 1	Bit 0
Inputs	0	DI7 C3P2 (B)	DI6 C3P4 (A)	DI5 C2P2 (B)	DI4 C2P4 (A)	DI3 C1P2 (B)	DI2 C1P4 (A)	DI1 C0P2 (B)	DI0 C0P4 (A)
	1	DI15 C7P2 (B)	DI14 C7P4 (A)	DI13 C6P2 (B)	DI12 C6P4 (A)	DI11 C5P2 (B)	DI10 C5P4 (A)	DI9 C4P2 (B)	DI8 C4P4 (A)
Diagnostics	2	Total diagnostics	-	-	-	Undervoltage V2	Undervoltage V1	-	-
	3	Vsens OC C7P1	Vsens OC C6P1	Vsens OC C5P1	Vsens OC C4P1	Vsens OC C3P1	Vsens OC C2P1	Vsens OC C1P1	Vsens OC C0P1
	4	DO7 SC	DO6 SC	DO5 SC	DO4 SC	DO3 SC	DO2 SC	DO1 SC	DO0 SC
	5	DO15 SC	DO14 SC	DO13 SC	DO12 SC	DO11 SC	DO10 SC	DO9 SC	DO8 SC
OUTPUT	BYTE	Bit 7	Bit 6	Bit 5	Bit 4	Bit 3	Bit 2	Bit 1	Bit 0
Outputs	0	DO7 C3P2 (B)	DO6 C3P4 (A)	DO5 C2P2 (B)	DO4 C2P4 (A)	DO3 C1P2 (B)	DO2 C1P4 (A)	DO1 C0P2 (B)	DO0 C0P4 (A)
	1	DO15 C7P2 (B)	DO14 C7P4 (A)	DO13 C6P2 (B)	DO12 C6P4 (A)	DO11 C5P2 (B)	DO10 C5P4 (A)	DO9 C4P2 (B)	DO8 C4P4 (A)