

TS720-LI2UPN8-H1141

Temperature Detection – With Current or Voltage Output and PNP/NPN Transistor Switching Output

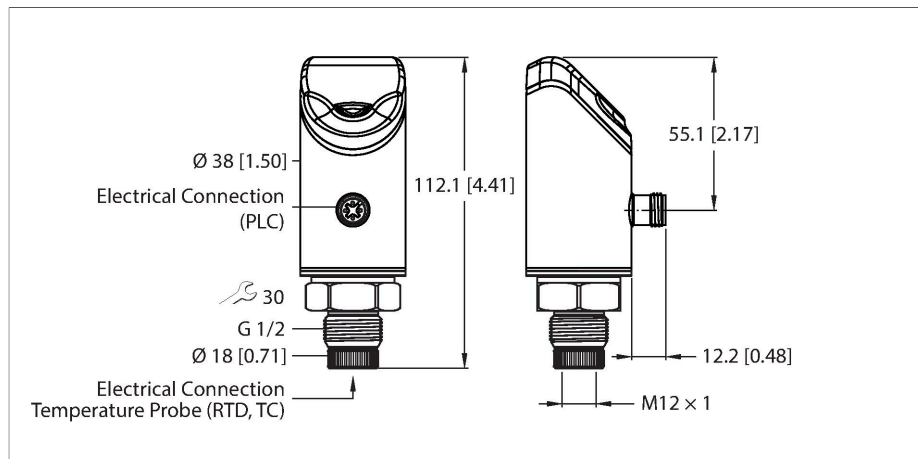

Technical data

Type	TS720-LI2UPN8-H1141
ID	100003640
Temperature range	
Measuring element	For connection to probes of the TP series
Response time	100 ms
Operating voltage	17...33 VDC
Protective measure	SELV, PELV according to DIN EN 61140
Short-circuit/reverse polarity protection	yes / yes
Insulation class	III
Outputs	
Output 1	Switching output or IO-Link mode
Output 2	Analog or switching output
Switching output	
Communication protocol	IO-Link
Output function	NO/NC programmable, PNP/NPN
Switching point accuracy	± 0.2 K
Rated operational current	0.25 A
Switching point distance	≥ 0.2 K
Switch point:	Probe dependent: (min. measuring range)...(max. measuring range — 0.2 K)
Release point(s)	Probe dependent: (min. measuring range — 0.2 K) ... (max. measuring range)
Switching cycles	≥ 100 mil.
Analog output	
Current output	4...20 mA
Alternative current output	0...20 mA

Features

- Processor unit for connecting sensors from the TP product series
- Automatic probe detection
- 4-digit, two-colored, 12-segment display, rotatable by 180°
- Upper part of housing can be rotated up to 340°
- 17...33 VDC
- NO/NC contact, PNP/NPN output, analog output (current/voltage), IO-Link
- Various IO-Link mapping profiles can be selected

Wiring diagram

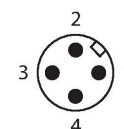
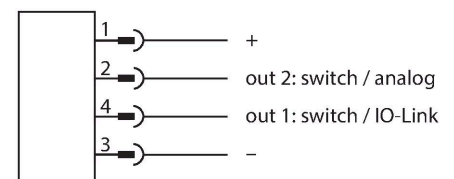

Functional principle

The TS+ product series is a compact processing unit with a 4-digit, 12-segment display that can be freely rotated by 340°. Compact units with (TS700) and without (TS720) temperature sensors as well as different output variants are available.

Technical data

Current output note	Each invertible
Voltage output	0...10 V
Alternative voltage output	0... 5 V
Alternative voltage output	1... 6 V
Alternative voltage output	0.5...4.5 V
Voltage output note	Each invertible
Accuracy (Lin. + Hys. + Rep.)	± 0.3 K
Remark	0.1% of full scale applies to temperatures > 200 °C
Repeatability	0.1 K
IO-Link	
IO-Link specification	V 1.1
Transmission physics	corresponds to 3-wire physics (PHY2)
Frame type	2.2
Transmission rate	COM 2 (38.4 kBaud)
Programming	FDT/DTM/selection of various mapping profiles
Genauigkeit	± 0.1 K
Included in the SIDI GSDML	Yes
Programming	
Programming options	Switching logic (PNP, NPN, Auto*), switching/release point; hysteresis/window mode; NO/NC; unit; IO-Link mapping profile; analog output (U, I, Auto*); 0 (4)... 20 mA, 0...(5) 10 VDC, 1...6 VDC, 0.5... 4.5 VDC; * factory settings
Housing material	Stainless-steel/Plastic, 1.4404 (AISI 316L)/Grilamid TR90 UV
Electrical connection	Connector, M12 × 1
Protection class	IP66 IP67 IP69K
Ambient temperature	-40...+80 °C
Storage temperature	-40...+85 °C
Shock resistance	50 g (11 ms) , DIN EN 60068-2-27
Vibration resistance	20 g (10...3000 Hz), DIN EN 60068-2-6
Tests/approvals	
UL registration number	E516036
Reference conditions acc. to IEC 61298-1	
Temperature	15...+25 °C
Atmospheric pressure	860...1060 hPa abs.
Humidity	10...95 % rel.
Auxiliary power	24 VDC

Technical data

Display	
Display	4-digit, two-colored (green/red), 12-segment display, rotatable by 180°
Switching state	2 × LEDs, Yellow
Unit display	4 x green LED (°C, °F, K, Ohm)

Technical data

Type	TS720-LI2UPN8-H1141
ID	100003640

Temperature range	
Measuring element	For connection to probes of the TP series
Response time	100 ms
Operating voltage	17...33 VDC
Voltage drop at I ₀	≤ 2 V
Protective measure	SELV, PELV according to DIN EN 61140
Short-circuit/reverse polarity protection	yes / yes
Protection type and class	IP66 IP67 IP69K / III

Outputs	
Output 1	Switching output or IO-Link mode
Output 2	Analog or switching output

Switching output	
Communication protocol	IO-Link
Output function	NO/NC programmable, PNP/NPN
Switching point accuracy	± 0.2 K
Rated operational current	0.25 A
Switching current	≤ 250 mA
Switching point distance	≥ 0.2 K
Switch point:	Probe dependent: (min. measuring range)...(max. measuring range — 0.2 K)
Release point(s)	Probe dependent: (min. measuring range — 0.2 K) ... (max. measuring range)
Switching cycles	≥ 100 mil.

Analog output	
Current output	4...20 mA
Alternative current output	20...0 mA
Current output note	Each invertible
Voltage output	0...10 V
Alternative voltage output	0... 5 V
Alternative voltage output	1... 6 V
Alternative voltage output	0.5...4.5 V
Voltage output note	Each invertible

Technical data

Accuracy (Lin. + Hys. + Rep.)	± 0.3 K
Remark	0.1% of full scale applies to temperatures > 200 °C
Repeatability	0.1 K
IO-Link	
IO-Link specification	V 1.1
Programming	FDT/DTM/selection of various mapping profiles
Transmission physics	corresponds to 3-wire physics (PHY2)
Transmission rate	COM 2 (38.4 kBaud)
Frame type	2.2
Genauigkeit	± 0.1 K
Included in the SIDI GSDML	Yes
Ambient temperature	-40...+80 °C
Storage temperature	-40...+85 °C
Vibration resistance	20 g (10...3000 Hz), DIN EN 60068-2-6
Shock resistance	50 g (11 ms) , DIN EN 60068-2-27
Housing material	Stainless-steel/Plastic, 1.4404 (AISI 316L)/Grilamid TR90 UV
Electrical connection	Connector, M12 × 1
Reference conditions acc. to IEC 61298-1	
Temperature	15...+25 °C
Atmospheric pressure	860...1060 hPa abs.
Humidity	10...95 % rel.
Auxiliary power	24 VDC
Display	
Display	4-digit, two-colored (green/red), 12-seg-ment display, rotatable by 180°
Switching state	2 × LEDs, Yellow
Unit display	4 x green LED (°C, °F, K, Ohm)
Programming	
Programming options	Switching logic (PNP, NPN, Auto*), switching/release point; hysteresis/win-dow mode; NO/NC; unit; IO-Link mapping profile; analog output (U, I, Auto*); 0 (4)... 20 mA, 0...(5) 10 VDC, 1...6 VDC, 0.5... 4.5 VDC; * factory settings
Tests/approvals	
Approvals	cULus
UL registration number	E516036

Status LEDs

LED	Color	Status	Description
PWR	Green	On	Operating voltage applied Device is operational
		Flashing	Operating voltage applied IO-Link communication active (inverted flash with T on 900 ms and T off 100 ms)
FLT	Red	On	Error displayed (For error pattern in combination with LEDs see manual)
		Off	No errors displayed
°C	Green	On	Temperature in °C
°F	Green	On	Temperature in °F
K	Green	On	Temperature in K
Ω	Green	On	Resistance in Ω
LOC	Yellow	On	Device locked
		Flashing	"Lock/unlock" process is active
		Off	Device unlocked
I and II (switching point of LEDs)	Yellow	On	Switching output -NO: switching point exceeded/within window (active output) -NC: switching point undershot/outside window (active output)
		Off	Switching output -NO: switching point undershot/outside window (inactive output) -NC: switching point exceeded/within window (inactive output)

For detailed description of the display patterns and flashing codes, see manual

IO-Link process data image

Bit	15	14	13	12	11	10	9	8	7	6	5	4	3	2	1	0
Byte n	14 Bit Process Value (TEMP)														State Out 2	State Out 1

Accessories

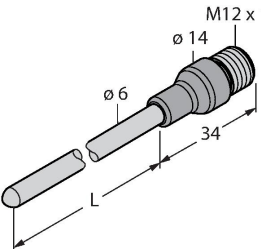
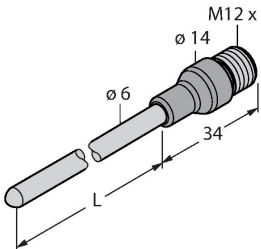
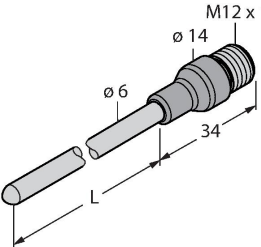
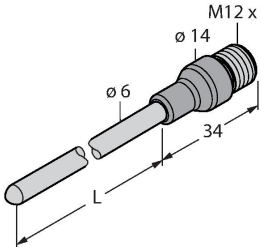
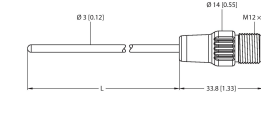
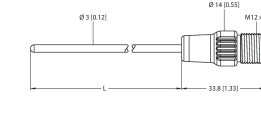
 <p>TP-206A-CF-H1141-L100</p>	<p>9910475</p> <p>temperature detector for liquid and gaseous media</p>	 <p>TP-206A-CF-H1141-L150</p>	<p>9910476</p> <p>temperature detector for liquid and gaseous media</p>
 <p>TP-206A-CF-H1141-L200</p>	<p>9910477</p> <p>temperature detector for liquid and gaseous media</p>	 <p>TP-206A-CF-H1141-L300</p>	<p>9910478</p> <p>temperature detector for liquid and gaseous media</p>
 <p>TP-203A-CF-H1141-L100</p>	<p>9910402</p> <p>temperature detector for liquid and gaseous media</p>	 <p>TP-203A-CF-H1141-L150</p>	<p>9910403</p> <p>temperature detector for liquid and gaseous media</p>

TP-203A-CF-H1141-L200

9910482

temperature detector for liquid and gaseous media

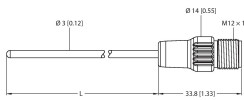

TP-203A-CF-H1141-L300

9910474

temperature detector for liquid and gaseous media

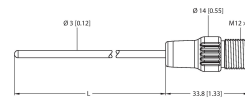

TP-306A-CF-H1141-L1000

9910479

temperature detector for liquid and gaseous media

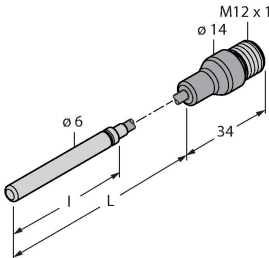

TP-306A-CF-H1141-L2000

9910480

temperature detector for liquid and gaseous media

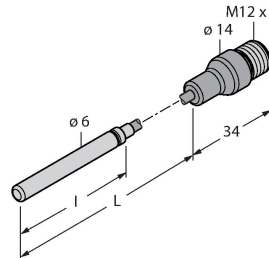

TP-306A-CF-H1141-L5000

9910481

temperature detector for liquid and gaseous media

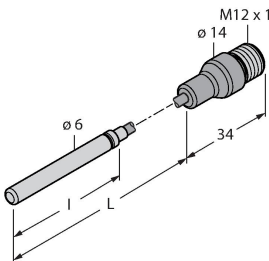

TP-504A-TRI3/4-H1141-L035

9910429

temperature detector for liquid and gaseous media

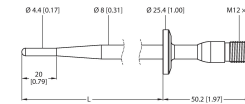

TP-504A-TRI3/4-H1141-L100

9910430

temperature detector for liquid and gaseous media

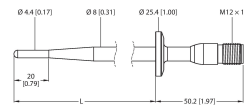

TP-504A-TRI1.5-H1141-L100

9910860

temperature detector for liquid and gaseous media

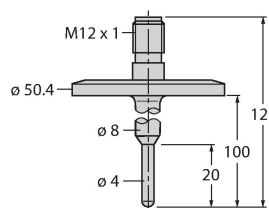

TP-504A-DN25K-H1141-L035

9910431

temperature detector for liquid and gaseous media

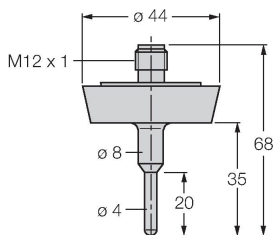

TP-504A-DN25K-H1141-L100

9910432

temperature detector for liquid and gaseous media

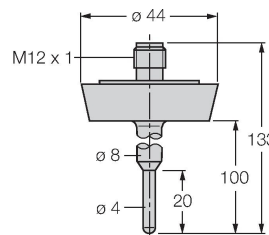

TP-206KK1-CF-H1141-L100

100017085

temperature detector for liquid and gaseous media

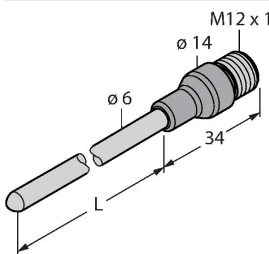

TP-206KK1-CF-H1141-L150

100017084

temperature detector for liquid and gaseous media

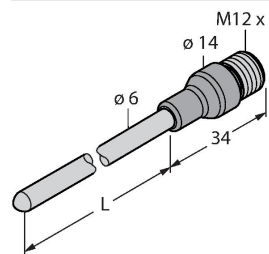

TP-206KK1-CF-H1141-L200

100017083

temperature detector for liquid and gaseous media

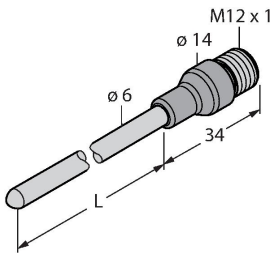

CF-M-3-G1/8-A4

9910405

Compression fitting for direct mounting of temperature sensors; sensor diameter 3 mm; process connection G1/8" male thread

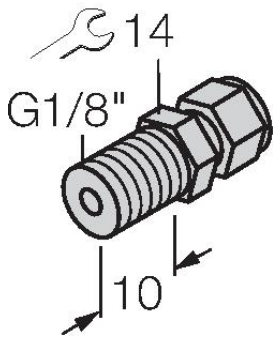

TP-206KK1-CF-H1141-L500

100017082

temperature detector for liquid and gaseous media

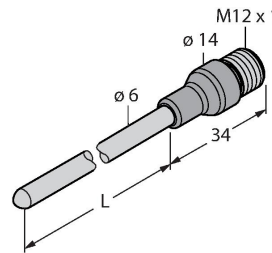

CF-M-3-G1/4-A4

9910407

Compression fitting for direct mounting of temperature sensors; sensor diameter 3 mm; process connection G1/4" male thread

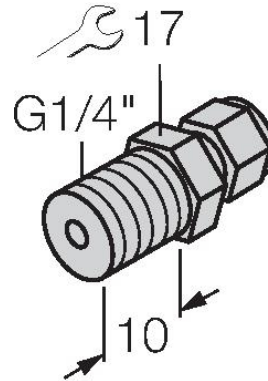

CF-M-3-N1/8-A4

9910406

Compression fitting for direct mounting of temperature sensors; sensor diameter 6 mm; process connection 1/8" NPT male thread

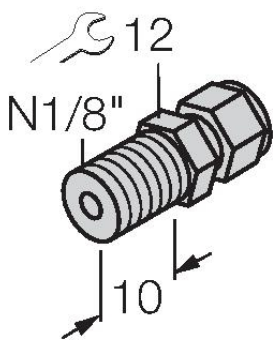

CF-M-3-N1/4-A4

9910408

Compression fitting for direct mounting of temperature sensors; sensor diameter 3 mm; process connection 1/4" NPT male thread

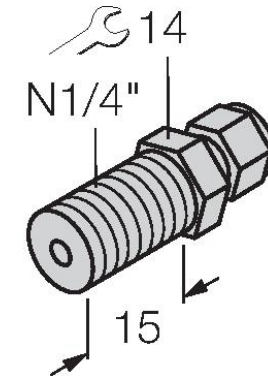

CF-M-6-G1/4-A4

9910483

Compression fitting for direct mounting of temperature sensors; sensor diameter 6 mm; process connection G1/4" male thread

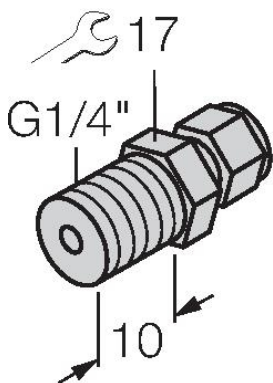

CF-M-6-G1/2-A4

9910530

Compression fitting for direct mounting of temperature sensors; sensor diameter 6 mm; process connection G1/2" male thread

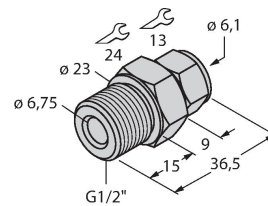

CF-M-6-N1/4-A4

9910484

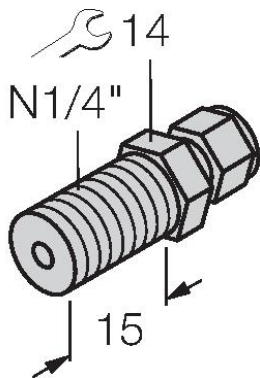

Compression fitting for direct mounting of temperature sensors; sensor diameter 6 mm; process connection 1/4" NPT male thread

CF-M-6-N1/2-A4

9910529

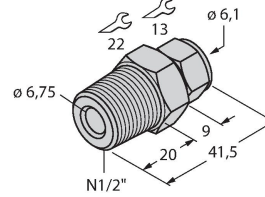

Compression fitting for direct mounting of temperature sensors; sensor diameter 6 mm; process connection 1/2" NPT male thread

THW-3-G1/2-A4-L050

9910443

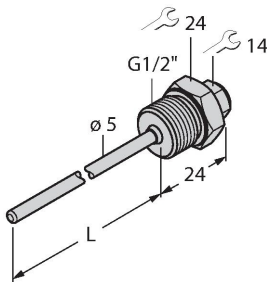

Protective tube for mounting temperature sensors; sensor diameter 3 mm; process connection G1/2" external thread; immersion depth 50 mm

THW-3-G1/2-A4-L100

9910444

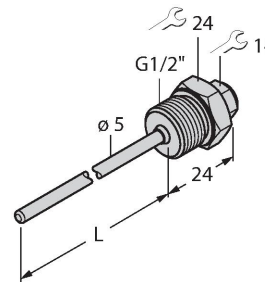

Protective tube for mounting temperature sensors; sensor diameter 3 mm; process connection G1/2" external thread; immersion depth 100 mm

THW-3-G1/2-A4-L200

9910487

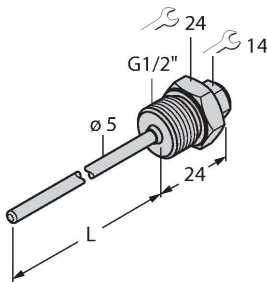

Protective tube for mounting temperature sensors; sensor diameter 3 mm; process connection G1/2" external thread; immersion depth 200 mm

THW-3-G1/2-A4-L250

9910446

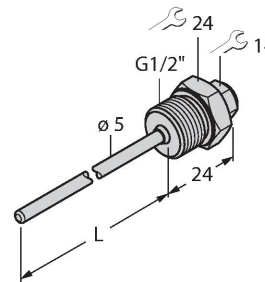

Protective tube for mounting temperature sensors; sensor diameter 3 mm; process connection G1/2" external thread; immersion depth 250 mm

TP-306A-CF-H1141-L5500

100024018

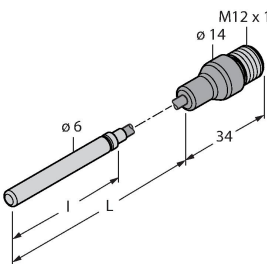

temperature detector for liquid and gaseous media

FAM-30-PA66

100018384

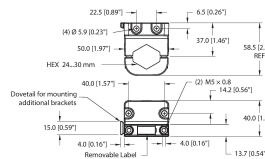

Mounting bracket; variable wrench size 24–30 mm; removable labeling plate 20 × 9 mm

TP-206KK1-CF-H1141-L1000

100034627

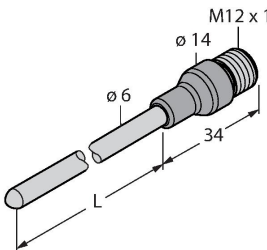

temperature detector for liquid and gaseous media

TP-203A-M6-H1141-L100-I7

100041106

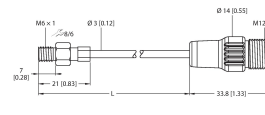

temperature detector for liquid and gaseous media

TP-203KK1-CF-H1141-L150

100045292

temperature detector for liquid and gaseous media

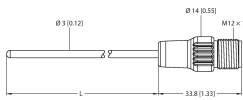

Accessories

Dimension drawing	Type	ID	
	RKC4.4T-2-RSC4.4T/TEL	6625208	Connection cable, M12 female plug, straight, 4-pin, cable length: 2 m, sheath material: PVC, black; cULus approval; other cable lengths and qualities available, see www.turck.com
	RKC4.4T-2-RSC4.4T/TXL	6625608	Extension cable, M12 female connector, straight, 4-pin to M12 male connector, straight, 4-pin; cable length: 2 m, jacket material: PUR, black; cULus approval; other cable lengths and versions available, see www.turck.com
	HT-WAK4-2-HT-WAS4/S2430	8038668	High-temperature-resistant extension cable, M12 female, straight, 4-pin to M12 male, straight, 4-pin; cable length: 2 m, jacket material: PTFE, white; other cable lengths and qualities available, see www.turck.com
	RKH4.4-2-RSH4.4/TFG	6933472	Food and Beverage extension cable, M12 female, straight, 4-pin to M12 male, straight, 4-pin; cable length: 2 m, jacket material: TPE, gray; approval: Ecolab, FDA; other cable lengths and qualities available, see www.turck.com