

# REI-10S12C-2B2048-H1181

## Incremental Encoder

### Industrial Line

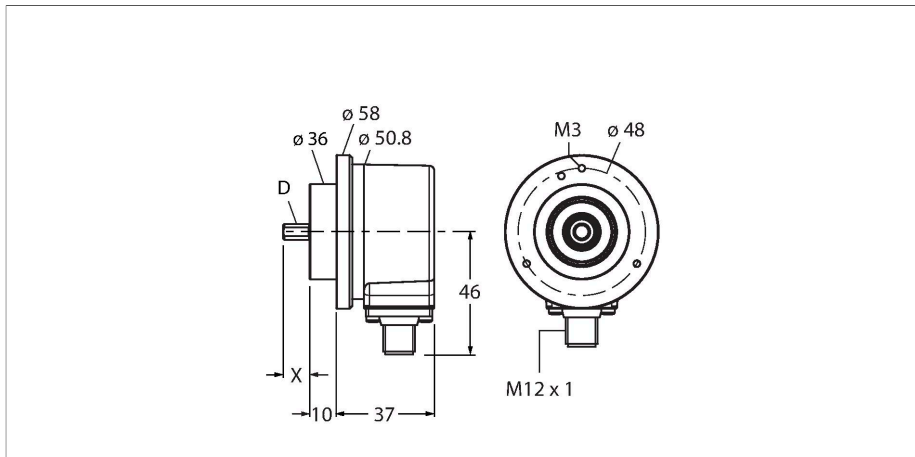

#### Technical data

Type	REI-10S12C-2B2048-H1181
ID	100010238
Measuring principle	Optical
<b>General data</b>	
Max. Rotational Speed	6000 rpm
Moment of inertia of the rotor	$1.8 \times 10^{-5} \text{ kgm}^2$
Starting torque	< 0.05 Nm
Output type	Incremental
Resolution, incremental	2048 ppr
<b>Electrical data</b>	
Operating voltage	10...30 VDC
No-load current	100 mA
Output current	≤ 30 mA
Short-circuit protection	yes
Wire breakage/Reverse polarity protection	yes
Pulse frequency max.	300 kHz
Signal level high	min. $U_B - 1 \text{ V}$
Signal level low	max. 0.5 V
Output function	Push-Pull/HTL, invertable
<b>Mechanical data</b>	
Design	Solid shaft
Flange type	Clamping flange
Flange diameter	Ø 58 mm
Shaft Type	Solid shaft
Shaft diameter D [mm]	12

#### Features

- Clamping flange, Ø 58 mm
- Solid shaft, Ø 12 mm × 20 mm
- Optical measuring principle
- Shaft material: stainless steel
- Protection class IP67 on housing and shaft side
- -40...+85 °C
- Max. 6000 rpm (continuous operation 3000 rpm)
- 10...30 VDC
- Push-pull/HTL invertible
- Pulse frequency max. 300 kHz
- M12 × 1 male connector, 8-pin
- 2048 pulses per revolution

#### Wiring diagram

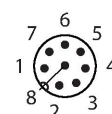
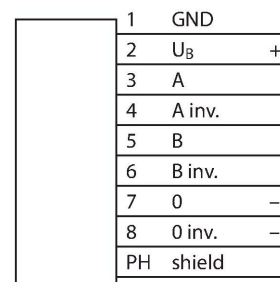

## Technical data

Shaft Length L [mm]	20
Shaft material	Stainless steel
Housing material	Die-cast zinc
Electrical connection	Connector, M12 × 1
	8-pin
Axial shaft load	50 N
Radial shaft load	100 N
<b>Environmental conditions</b>	
Ambient temperature	-40...+85 °C
Vibration resistance (EN 60068-2-6)	300 m/s <sup>2</sup> , 10...2000 Hz
Shock resistance (EN 60068-2-27)	3000 m/s <sup>2</sup> , 6 ms
Protection class	IP67
Protection class shaft	IP67

## Accessories

**RFA-2** 1544631

Aluminium flange adapter, rectangular, for solid shaft encoders with clamping flange; edge length 63.5 mm; 3 mm thick

**RFA-13** 1544642

Aluminium flange adapter, rectangular, for solid shaft encoders with clamping flange; edge length 80 mm; 4 mm thick

**RFA-1** 1544630

Aluminium flange adapter, rectangular, for solid shaft encoders with clamping flange; edge length 58 mm; 4 mm thick

**RFA-4** 1544633

Euro flange – aluminium flange adapter for solid shaft encoders, Ø 115 mm; reference diameter 100 mm; adapts 58 mm clamping flange to Euro flange

**RFA-6** 1544635

Aluminium flange adapter for solid shaft encoders with clamping flange, Ø 58 mm; adapts clamping flange to synchro flange

**RFA-7** 1544636

Aluminium flange adapter for solid shaft encoders, Ø 65 mm; adapts to Ø 65 mm flange and 48 mm reference diameter

RFA-8

1544637

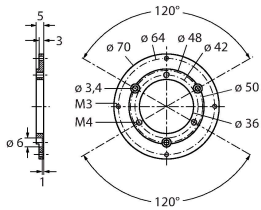

Aluminium flange adapter for solid shaft encoders with clamping flange, Ø 70 mm; thickness 4 mm, adapts to Ø 70 mm flange

RFA-9

1544638

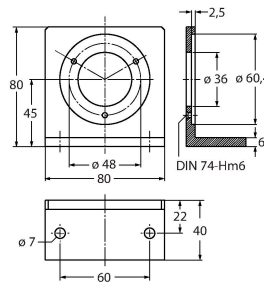

Aluminium angle flange for solid shaft encoders with Ø 58 mm clamping flange

RFA-11

1544640

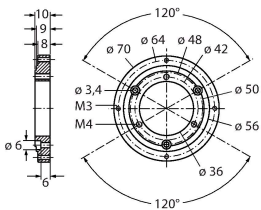

Aluminium flange adapter for solid shaft encoders with clamping flange, Ø 70 mm; thickness 10 mm, adapts to Ø 70 mm flange

RFA-12

1544641

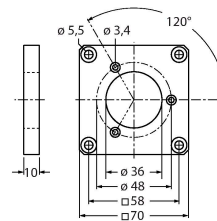

Aluminium flange adapter, rectangular, for solid shaft encoders with clamping flange; edge length 70 mm; 10 mm thick

## Accessories

Dimension drawing	Type	ID	
	RKC8T-2/TXL	6625142	Connection cable, M12 female connector, straight, 8-pin, cable length: 2 m, jacket material: PUR, black; cULus approval
	WKC8T-2/TXL	6625145	Connection cable, M12 female connector, angled, 8-pin, cable length: 2 m, jacket material: PUR, black; cULus approval