

REM-116T6S-7AAL-H1151

Absolute Rotary Encoder - Multiturn Industrial Line

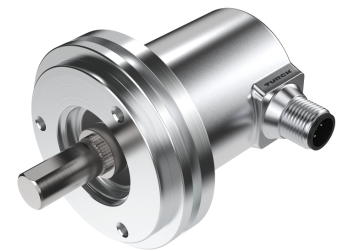
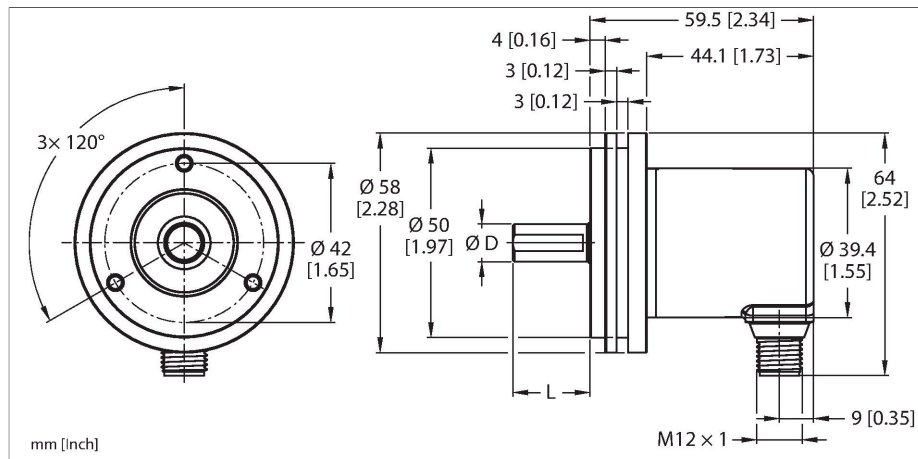

Technical data

Type	REM-116T6S-7AAL-H1151
ID	100011417
Measuring principle	Magnetic
General data	
Max. Rotational Speed	4000 rpm
Absolute accuracy	± 1 ° At 25 °C
Output type	Absolute multiturn
Electrical data	
Operating voltage	10...30 VDC
No-load current	38 mA
Short-circuit protection	yes
Wire breakage/Reverse polarity protection	yes
Output function	Analog output
Current output	4...20 mA
DA converter resolution	12 Bit
Mechanical data	
Design	Solid shaft
Flange type	Synchro flange
Flange diameter	Ø 58 mm
Shaft Type	Solid shaft
Shaft diameter D [mm]	6
Shaft Length L [mm]	12.5
Shaft material	Stainless steel
Housing material	Die-cast zinc
Electrical connection	Connector, M12 × 1

Features

- Synchro flange, Ø 58 mm
- Solid shaft, Ø 6 mm × 12.5 mm
- Magnetic measuring principle
- Shaft material: stainless steel
- Protection class IP65 on housing and shaft side
- -40...+85°C
- Max. 4000 rpm (continuous operation: 2000)
- Energy harvesting technology
- 10...30 VDC
- Analog output, 4...20 mA per 16 CCW revolutions
- 12-bit resolution
- M12 × 1 male, 5-pin

Wiring diagram

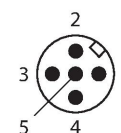
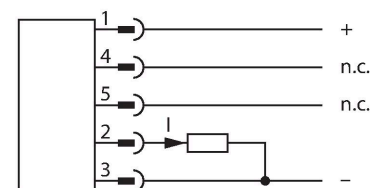

Technical data

	5-pin
Axial shaft load	40 N
Radial shaft load	80 N
Environmental conditions	
Ambient temperature	-40...+85 °C
Vibration resistance (EN 60068-2-6)	30 g (300 m/s ²), 10...2000 Hz
Shock resistance (EN 60068-2-27)	500 g (2500 m/s ²), 4 ms
Protection class	IP65
Protection class shaft	IP65

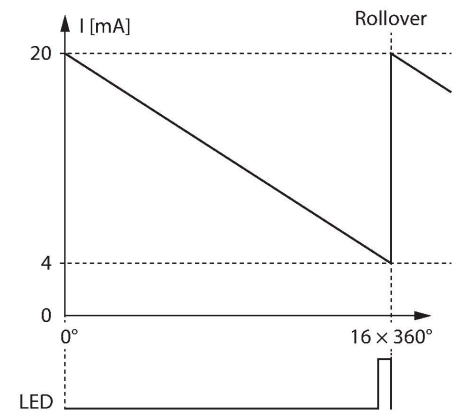

Accessories

RCS-19-06-06 **1545360**
 Bellows coupling, outer diameter:
 19 mm, bore diameter: 6 mm/6 mm

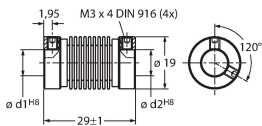

RCS-15-08-06 **1545361**
 Bellows coupling, outer diameter:
 15 mm, bore diameter: 8 mm/6 mm

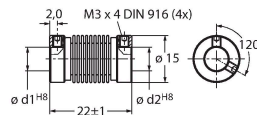

RCS-15-06-06 **1545362**
 Bellows coupling, outer diameter:
 15 mm, bore diameter: 6 mm/6 mm

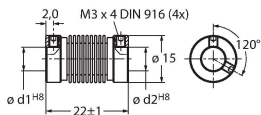

RCS-15-06-04 **1545363**
 Bellows coupling, outer diameter:
 15 mm, bore diameter: 6 mm/4 mm

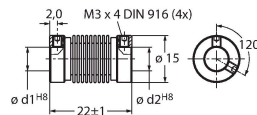

RCS-19-10-06 **1545358**
 Bellows coupling, outer diameter:
 19 mm, bore diameter: 10 mm/6 mm

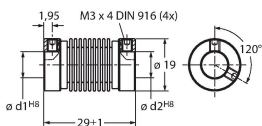

Accessories

Dimension drawing	Type	ID	
	RKC4.5T-2/TEL	6625016	Connection cable, M12 female connector, straight, 5-pin, cable length: 2 m, jacket material: PVC, black; cULus approval

