

REI-E-114I10T-2B512-H1181

Incremental Encoder

Efficiency Line

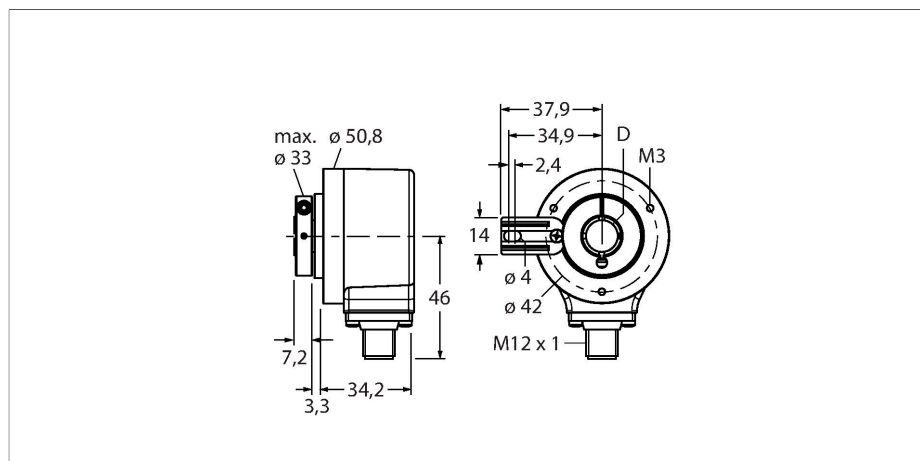

Technical data

Type	REI-E-114I10T-2B512-H1181
ID	100011673
Measuring principle	Optical
General data	
Max. Rotational Speed	4500 rpm
Moment of inertia of the rotor	$6 \times 10^{-6} \text{ kgm}^2$
Starting torque	< 0.05 Nm
Output type	Incremental
Resolution, incremental	512 ppr
Electrical data	
Operating voltage	10...30 VDC
No-load current	100 mA
Output current	≤ 30 mA
Short-circuit protection	yes
Wire breakage/Reverse polarity protection	yes
Pulse frequency max.	300 kHz
Signal level high	min. $U_B - 1 \text{ V}$
Signal level low	max. 0.5 V
Output function	Push-Pull/HTL, invertable
Mechanical data	
Design	Hollow shaft
Flange type	Flange with mounting element
Flange diameter	Ø 50.8 mm
Shaft Type	Hollow shaft
Shaft diameter D [mm]	10

Features

- Flange with torque stop
- Hollow shaft, Ø 10 mm
- Optical measuring principle
- Shaft material: stainless steel
- Protection class IP64 on housing and shaft side
- -20...+70 °C
- Max. 4500 rpm (continuous operation 3000 rpm)
- 10...30 VDC
- Push-pull/HTL invertible
- Pulse frequency max. 300 kHz
- M12 × 1 male connector, 8-pin
- 512 pulses per revolution

Wiring diagram

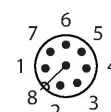
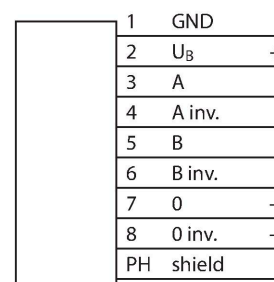

Technical data

Shaft material	Stainless steel
Housing material	Die-cast zinc
Electrical connection	Connector, M12 × 1
	8-pin
Axial shaft load	40 N
Radial shaft load	80 N
Environmental conditions	
Ambient temperature	-20...+70 °C
Vibration resistance (EN 60068-2-6)	100 m/s ² , 10...2000 Hz
Shock resistance (EN 60068-2-27)	1000 m/s ² , 6 ms
Protection class	IP64
Protection class shaft	IP64

Accessories

RME-1

1544612

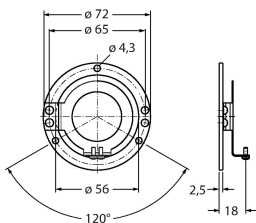

Stainless steel stator coupling for hollow shaft encoders, reference diameter, 65 mm, for highly dynamic, standard applications with axial and radial play

RME-2

1544613

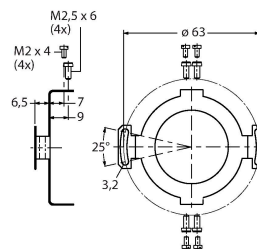

Stainless steel stator coupling for hollow shaft encoders, reference diameter 63 mm, for applications with high demands on accuracy

RME-4

1544615

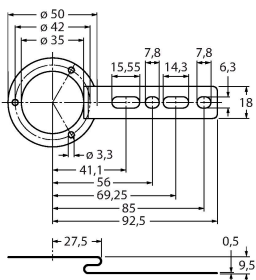

Stainless steel mounting panel for hollow shaft encoders, reference diameter 80...170 mm, for low dynamic applications with axial and radial play

RME-7

1544618

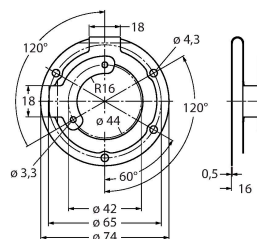

Stainless steel stator coupling for hollow shaft encoders, reference diameter 65 mm, for highly dynamic applications with axial and radial play

RME-8

1544619

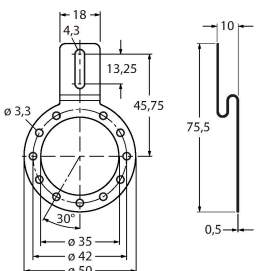

Stainless steel mounting panel for hollow shaft encoders, reference diameter 65...91.5 mm, for applications with axial and radial play at constant rotation speed

RME-9

1544620

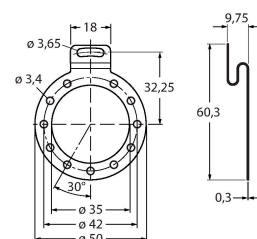

Stainless steel mounting panel for hollow shaft encoders, reference diameter 64.5 mm, for low dynamic applications with axial and radial play

RME-13

1544624

Plastic mounting element for hollow shaft encoders, pitch diameter 42 mm, for applications with limited axial play, low dynamics and limited mounting space

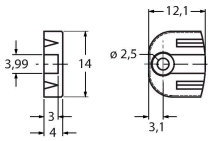

RME-14

1544625

Plastic mounting element for hollow shaft encoders, pitch diameters 44 mm, 60 mm, 63 mm, 65 mm, for low dynamic applications with high axial play.

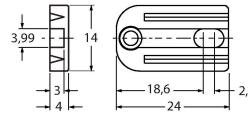

Accessories

Dimension drawing	Type	ID	
	RKC8T-2/TXL	6625142	Connection cable, M12 female connector, straight, 8-pin, cable length: 2 m, jacket material: PUR, black; cULus approval
	WKC8T-2/TXL	6625145	Connection cable, M12 female connector, angled, 8-pin, cable length: 2 m, jacket material: PUR, black; cULus approval