

# TP-206KK1-CF-H1141-L1000

## Temperature Detection – Probe

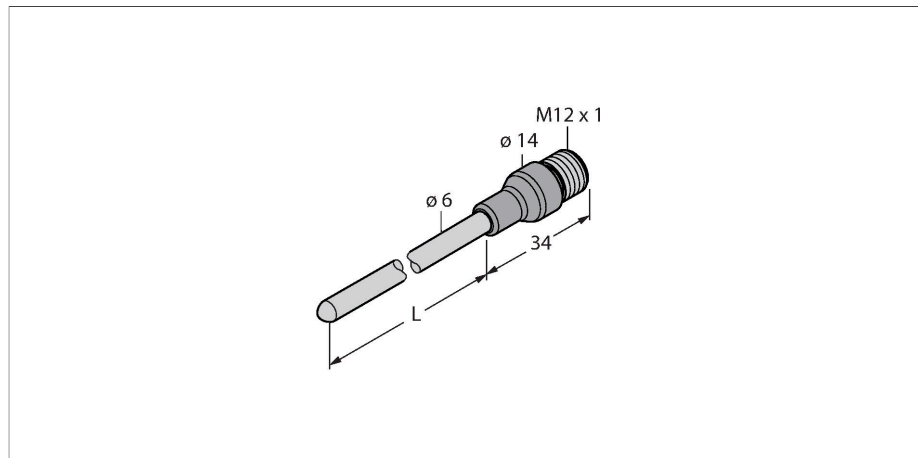

### Features

- Thermocouple acc. to DIN EN 60584
- Resistant to vibrations and shocks
- Can be connected to TS720, IM34 or IME-TI
- Max. temperature connector: 120 °C
- 2-wire technology
- Process connection: Compression Fitting
- Bendable probe (min. bending radius: 3x outside diameter)

### Wiring diagram

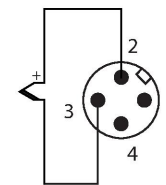

### Technical data

Type	TP-206KK1-CF-H1141-L1000
ID	100034627
<b>Temperature range</b>	
Measuring range	-40...1100 °C
Measuring range	-40...2012 °F
Accuracy	Class 1
Measuring element	Thermocouple type K, DIN EN 60584
Immersion depth (L)	1000 mm
Outer diameter	6 mm
Protection type and class	IP67
Output function	2-wire
<b>Environmental conditions</b>	
Ambient temperature	-40...+85 °C
Storage temperature	-40...+85 °C
<b>Mechanical data</b>	
Housing material	Metal/plastic, Inconel 600/Nylon
Sensor material	Metal, Inconel 600
Process connection	For compression fittings, thermowell or direct mounting
Electrical connection	Connector, M12 × 1
<b>Reference conditions acc. to IEC 61298-1</b>	
Temperature	15...+25 °C
Atmospheric pressure	860...1060 hPa abs.
Humidity	45...75 % rel.
Auxiliary power	24 VDC

### Functional principle

Thermocouples are used for the detection and monitoring of temperatures to optimize and control a process. Typical applications are in machine and plant construction as well as in the process industry. The core element of the temperature probe is a pair of metallic conductors that are made of different materials and connected at one end. Due to the thermoelectric effect, the thermocouple provides a temperature-dependent voltage.

Accessories

CF-M-6-G1/4-A4 9910483

Compression fitting for direct mounting of temperature sensors; sensor diameter 6 mm; process connection G1/4" male thread

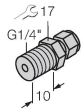

CF-M-6-N1/4-A4 9910484

Compression fitting for direct mounting of temperature sensors; sensor diameter 6 mm; process connection 1/4" NPT male thread

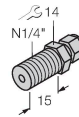

CF-M-6-M18-A4 9910525

Compression fitting for direct mounting of temperature sensors; sensor diameter 6 mm; process connection M18 x 1 male thread

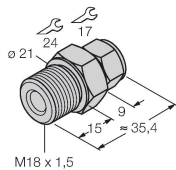

CF-M-6-N1/2-A4 9910529

Compression fitting for direct mounting of temperature sensors; sensor diameter 6 mm; process connection 1/2" NPT male thread

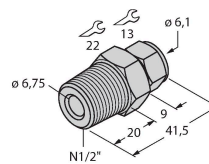

CF-M-6-G1/2-A4 9910530

Compression fitting for direct mounting of temperature sensors; sensor diameter 6 mm; process connection G1/2" male thread

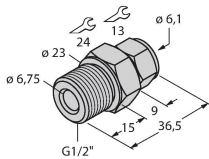

Accessories

Dimension drawing	Type	ID	
	RK4.217T-2-RS4.217T/TS7198	100033104	Thermocouple cable, type K — extension cable, M12 female connector, straight, 2-pin to M12 male connector, straight, 2-pin; cable length: 2 m, jacket material: TPE, green
	RK4.217T-5-RS4.217T/TS7198	100033105	Thermocouple cable, type K — extension cable, M12 female connector, straight, 2-pin to M12 male connector, straight, 2-pin; cable length: 5 m, jacket material: TPE, green

Dimension drawing	Type	ID
	RK4.217T-7-RS4.217T/TS7198	100033107

Thermocouple cable, type K — extension cable, M12 female connector, straight, 2-pin to M12 male connector, straight, 2-pin; cable length: 7 m, jacket material: TPE, green