

B2N60H-Q42-CNXX2-2H1150

Inclinometer – With CANopen Interface

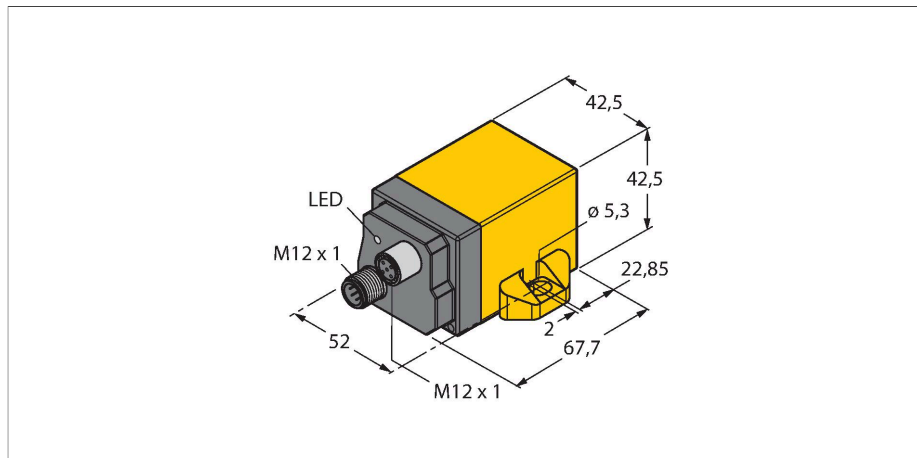

Features

- Rectangular, height 42 mm
- Plastic, PA12-GF30
- Convenient CANopen interface
- Fulfills CiA DS-301, CiA DSP-410
- High resolution and accuracy
- Baud rates of 10 kbps up to 1 Mbps
- High sampling rate and bandwidth
- Parameterizable vibration suppression
- One TPDO (RTR, cyclic, event-controlled, synchronized)
- Configuration via SDO and object directory
- SYNC load (synchronized transmission of TPDO after reception of SYNC telegram)
- EMCY producer (inclination, internal device temperature monitoring)
- Failure monitoring via heartbeat or node-guarding/lifeguarding
- Freely configurable limit frequency (digital filter)
- Robust and compact plastic housing

Technical data

Type	B2N60H-Q42-CNXX2-2H1150
ID	1534063
Measuring principle	Acceleration
General data	
Measuring range	-60...60 °
Measuring range x-axis	-60...60 °
Measuring range y-axis	-60...60 °
Number of measuring axes	2
Linearity deviation	max. ± 0.4 °
Temperature drift	≤ ± 0.01 %/K
Resolution	≤ 0.1 °
Electrical data	
Operating voltage	10...30 VDC
Limit frequency	typ. 20 Hz, 2.(without digital filter) 0.3 ... 25 Hz, 8. (with Butterworth, low-pass) The digital filter is deactivated with the value 0. Values between 300 (= 0.3 Hz) and 25000 (= 25 Hz) are allowed.
Interface	CANopen
Node ID	1...127 (Default 10)
Baud rate	10 kbps up to 1 Mbps admissible values 10 kbps, 20 kbps, 50 kbps, 125 kbps, 250 kbps, 500 kbps, 800 kbps and 1000 kbps (Default 500 kbps)
Sample rate	100 Hz
Current consumption	50...105 mA (voltage-dependent)
Mechanical data	
Design	Rectangular, Q42
Dimensions	67.7 x 42.5 x 42.5 mm
Housing material	Plastic, PA12-GF30

Wiring diagram

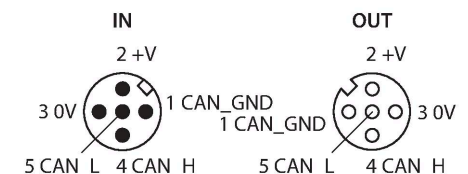

Functional principle

Inclination is determined by a wear-free semiconducting sensor element.

For more technical details, there is a manual available for download on the Internet.

Technical data

Electrical connection	Connector, M12 × 1
Environmental conditions	
Ambient temperature	-40...+80 °C
Vibration resistance	55 Hz (1 mm)
Shock resistance	30 g (11 ms)
Protection class	IP68 IP69K
MTTF	55 years acc. to SN 29500 (Ed. 99) 40 °C
Power-on indication	LED, Green
Error indication	LED, red