

# NI15-M30-LIU

## Inductive Sensor – With Analog Output

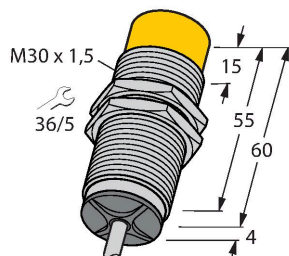

### Features

- M30 × 1.5 threaded tube
- Chrome-plated brass
- 4-wire, 15...30 VDC
- Analog output
- 0...10 V and 0...20 mA
- Cable connection

### Wiring diagram

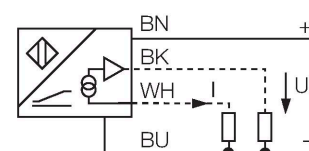

### Functional principle

Inductive TURCK sensors with analog output accomplish simple control tasks. They provide a current, voltage or frequency signal proportional to the target's distance. The output signal is linear to the distance of the target over the entire sensing range.

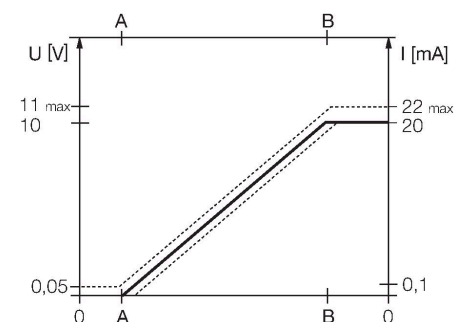

### Technical data

Type	NI15-M30-LIU
ID	1535300
<b>General data</b>	
Measuring range	2...12 mm
Mounting conditions	Non-flush
Secured operating distance	$\leq (0.81 \times S_n)$ mm
Correction factors	St37 = 1; Al = 0.3; stainless steel = 0.7; Ms = 0.4
Repeatability	$\leq 1$ % of measuring range  A - B
	0.5 %, after warm-up 0.5 h
Reproducibility	$\leq 100$ $\mu$ m
	$\leq 50$ $\mu$ m, after a warm-up time of 0.5 h
Linearity deviation	$\leq 3$ %
Temperature drift	$\leq \pm 0.06$ %/K
<b>Electrical data</b>	
Operating voltage	15...30 VDC
Residual ripple	$\leq 10$ % $U_{ss}$
No-load current	8 mA
Isolation test voltage	$\leq 0.5$ kV
Short-circuit protection	yes
Wire breakage/Reverse polarity protection	no / Complete
Output function	4-wire, Analog output
Voltage output	0...10 V
Current output	0...20 mA
Load resistance voltage output	$\geq 4.7$ k $\Omega$
Load resistance current output	$\leq 0.4$ k $\Omega$
Measuring sequence frequency	60 Hz

## Technical data

Mechanical data	
Design	Threaded barrel, M30 x 1.5
Dimensions	64 mm
Housing material	Metal, CuZn, Chrome-plated
Active area material	Plastic, PA12-GF30
End cap	Plastic, EPTR
Max. tightening torque of housing nut	75 Nm
Electrical connection	Cable
Cable quality	Ø 5.2 mm, Gray, LifYY, PVC, 2 m
Core cross-section	4 x 0.34 mm <sup>2</sup>
Environmental conditions	
Ambient temperature	-25...+70 °C
Vibration resistance	55 Hz (1 mm)
Shock resistance	30 g (11 ms)
Protection class	IP67
MTTF	751 years acc. to SN 29500 (Ed. 99) 40 °C

## Mounting instructions

Mounting instructions/Description		
	Distance D	90 mm
	Distance W	36 mm
	Distance T	3 x B
	Distance S	45 mm
	Distance G	72 mm
	Distance N	2 x Sn
	Diameter active area B	Ø 30 mm

## Accessories

BST-30B

6947216

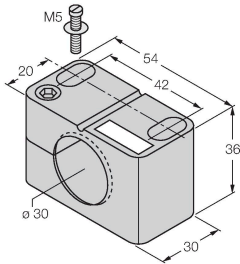

Mounting clamp for threaded barrel sensors, with dead-stop; material: PA6

QM-30

6945103

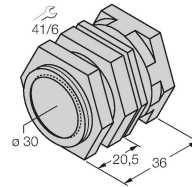

Quick-mount bracket with dead-stop; material: Chrome-plated brass. Male thread M36 × 1.5. Note: The switching distance of the proximity switches may change when using quick-mount brackets.

MW-30

6945005

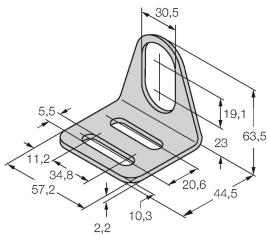

Mounting bracket for threaded barrel sensors; material: Stainless steel A2 1.4301 (AISI 304)

BSS-30

6901319

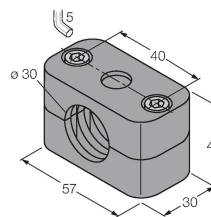

Mounting clamp for smooth and threaded barrel sensors; material: Polypropylene

## Accessories

Dimension drawing

Type

ID

IM43-13-SR

7540041

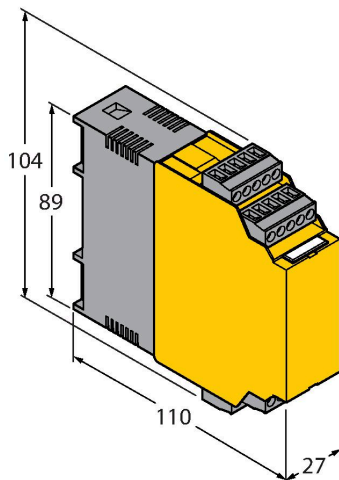

Trip amplifier; 1-channel; input 0/4... 20 mA or 0/2... 10 V; supply of 2- or 3-wire transmitters/sensors; limit value adjustment via teach button; three relay outputs with one NO contact each; removable terminal blocks; 27 mm wide; universal voltage supply 20...250 VUC; further Limit value indicators are described in our "Interface Technology" catalog.