

BI2-M12-LIU-H1141

Inductive Sensor – With Analog Output

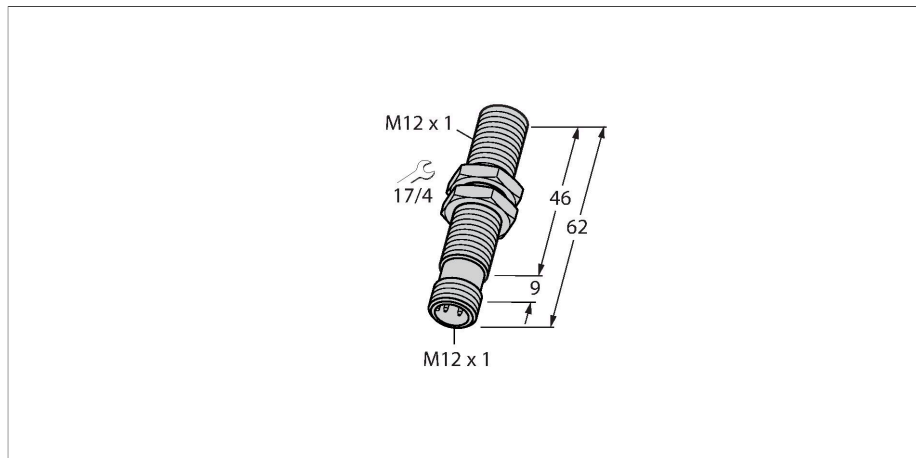

Features

- M12 × 1 threaded barrel
- Chrome-plated brass
- 4-wire, 15...30 VDC
- Analog output
- 0...10 V and 0...20 mA
- M12 × 1 male connector

Wiring diagram

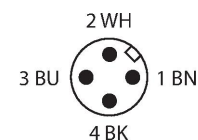
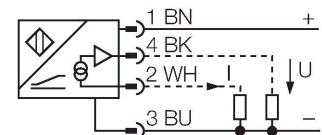

Technical data

Type	BI2-M12-LIU-H1141
ID	1535533
General data	
Measuring range	1...2.5 mm
Mounting conditions	Flush
Secured operating distance	$\leq (0.81 \times S_n)$ mm
Correction factors	St37 = 1; Al = 0.3; stainless steel = 0.7; Ms = 0.4
Repeatability	$\leq 1\%$ of measuring range A - B
	0.5 %, after warm-up 0.5 h
Reproducibility	$\leq 15\ \mu\text{m}$
	$\leq 7.5\ \mu\text{m}$, after a warm-up time of 0.5 h
Linearity deviation	$\leq 3\%$
Temperature drift	$\leq \pm 0.06\ \%/K$
Electrical data	
Operating voltage U_b	15...30 VDC
Ripple U_{ss}	$\leq 10\%$ U_{Bmax}
No-load current	$\leq 8\ \text{mA}$
Isolation test voltage	0.5 kV
Short-circuit protection	yes
Wire break/reverse polarity protection	no/Complete
Output function	4-wire, Analog output
Voltage output	0...10 V
Current output	0...20 mA
Load resistance voltage output	$\geq 4.7\ \text{k}\Omega$
Load resistance current output	$\leq 0.4\ \text{k}\Omega$
Measuring sequence frequency	200 Hz

Functional principle

Inductive TURCK sensors with analog output accomplish simple control tasks. They provide a current, voltage or frequency signal proportional to the target's distance. The output signal is linear to the distance of the target over the entire sensing range.

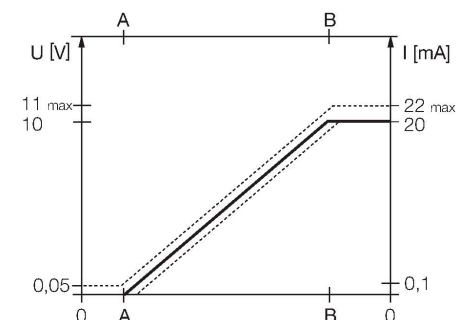

Technical data

Mechanical data	
Design	Threaded barrel, M12 x 1
Dimensions	62 mm
Housing material	Metal, CuZn, Chrome-plated
Active area material	Plastic, PA12-GF30
Max. tightening torque of housing nut	10 Nm
Electrical connection	Connector, M12 x 1
Environmental conditions	
Ambient temperature	-25...+70 °C
Vibration resistance	55 Hz (1 mm)
Shock resistance	30 g (11 ms)
Protection class	IP67
MTTF	751 years acc. to SN 29500 (Ed. 99) 40 °C

Mounting instructions

Mounting instructions/Description		
	Distance D	24 mm
	Distance W	9 mm
	Distance T	3 x B
	Distance S	18 mm
	Distance G	18 mm
	Diameter active area B	Ø 12 mm

Accessories

QM-12 6945101

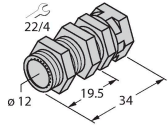

Quick-mount bracket with dead-stop; material: Chrome-plated brass. Male thread M16 × 1. Note: The switching distance of the proximity switches may change when using quick-mount brackets.

BST-12B 6947212

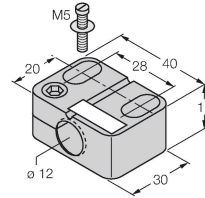

Mounting clamp for threaded barrel sensors, with dead-stop; material: PA6

MW12 6945003

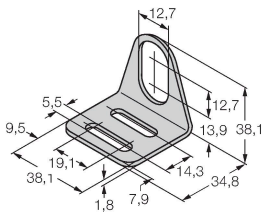

Mounting bracket for threaded barrel sensors; material: Stainless steel A2 1.4301 (AISI 304)

BSS-12 6901321

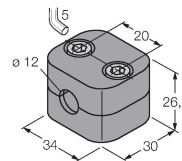

Mounting clamp for smooth and threaded barrel sensors; material: Polypropylene

Accessories

Dimension drawing	Type	ID	
-------------------	------	----	--

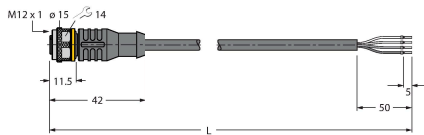

RKC4.4T-2/TEL 6625013

Connection cable, M12 female connector, straight, 4-pin, cable length: 2 m, jacket material: PVC, black; cULus approval

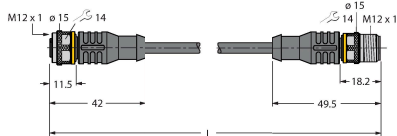

RKC4.301T-0.15-RSC4.334T/TXL 6631382

Extension cable, M12 female/male, straight, 4-pin, cable length: 0.15m, jacket material: PUR, black; cULus approval; Adapter cable for sensors with analog output on pin 2, for connection to analog inputs of fieldbus modules with 4-wire technology

Accessories

Dimension drawing	Type	ID	
	IM43-13-SR	7540041	<p>Trip amplifier; 1-channel; input 0/4... 20 mA or 0/2...10 V; supply of 2- or 3-wire transmitters/sensors; limit value adjustment via teach button; three relay outputs with one NO contact each; removable terminal blocks; 27 mm wide; universal voltage supply 20...250 VUC; further Limit value indicators are described in our "Interface Technology" catalog.</p>