

# LTX100M-F10-SSI2-GAF1-X3-H1161

## Pressure-Resistant Linear Position Sensor – SSI

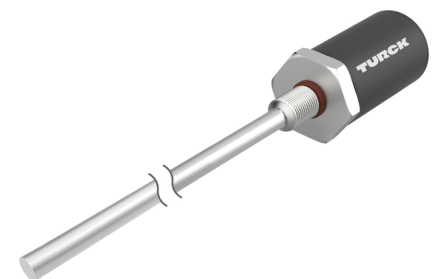

### Technical data

Type	LTX100M-F10-SSI2-GAF1-X3-H1161
ID	1540217
Remark to product	Please note housing design on page 2
Measuring principle	Magnetostrictive
<b>General data</b>	
Measuring range	100 mm
Resolution	0.005 mm
Blind zone a	50.8 mm
Blind zone b	63.5 mm
Repeat accuracy	≤ 0.01 % of full scale
Linearity deviation	≤ 0.01 % f.s.
Hysteresis	≤ 0.025 mm
<b>Electrical data</b>	
Operating voltage	7...30 VDC
Residual ripple	≤ 10 % U <sub>ss</sub>
Short-circuit protection	yes / Cyclic
Wire breakage/Reverse polarity protection	yes (voltage supply)
Communication protocol	SSI
Output function	6-pin, 25 Bit, Gray, asynchronous, Forward
Current consumption	< 60 mA at 24 VDC
<b>Mechanical data</b>	
Design	Rod
Dimensions	295.6 mm
Housing material	Metal, AL
Active area material	Stainless steel, 1.4404 (AISI 316L)
Electrical connection	Connector, M12 × 1

### Features

- Suited for hydraulic cylinders
- The sensor is pressure resistant up to 340 bar (permanent), 680 bar (short-term)
- Shock-proof up to 100g
- Status displayed via 3 color LED
- Resolution 0,005 mm
- Operating temperature rod -40 °C...+105 °C
- Operating temperature electronics -40 °C...+85 °C
- Protection class IP68
- 7...30 V DC power supply
- SSI - output, gray coded, 25 bit
- M12 x 1 connector

### Wiring diagram

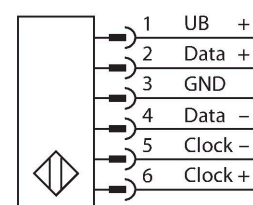

### Functional principle

The LTX is a magnetostrictive sensor, optimized for precise position control in hydraulic cylinders. With the assistance of optional floats, the magnetically actuated position sensors also implement additional fill level monitoring. The absolute value sensor is very robust and precise, and also saves the position information in the event of a voltage failure, so that additional zeroing is unnecessary. The sensors operate on the contactless function principle and are thus wear and maintenance free.

## Technical data

Environmental conditions	
Ambient temperature	-40...+85 °C
Vibration resistance	30 Hz (1 mm)
Shock resistance	100 g (11 ms)
Protection class	IP68
Measuring range display	multifunction LED

## Mounting instructions

### Mounting instructions/Description

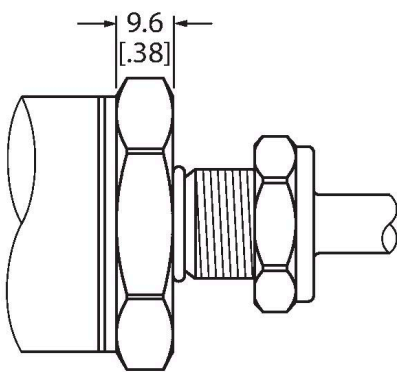

#### Flat Face Design

This sensor comes in flat face design (see drawing).

To fasten the sensor, the end cap of the hydraulic cylinder must have an M18 × 1.5 threaded bore according to ISO 6149-1. For more information, refer to the operating instructions.

## Accessories

### CM-R10 6900416

Standard positioning element, suitable for mounting in hydraulic cylinders

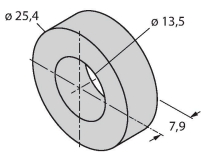

### STM-AL-R10 6900409

Standard 4-hole positioning element, material: Aluminum

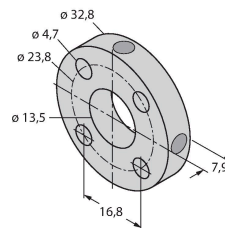

### LSPM-AL-R10 6900414

Ring-type positioning element with slot, can be used for external mounting with mounting bracket RB-R10, material: Aluminum

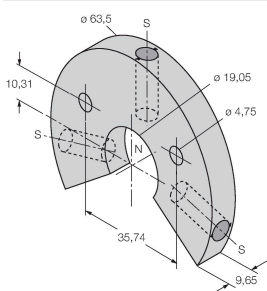

### EF-R10 6900417

Float-type positioning element, specific weight 0.62 kg/m<sup>3</sup>, suitable for external mounting for level monitoring, material: Stainless steel

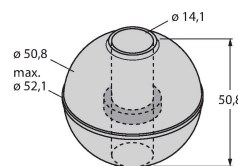

**STS-R10** 6900411

Standard spacer made of non-ferrous material for separating the positioning element from the base of the hydraulic piston rod

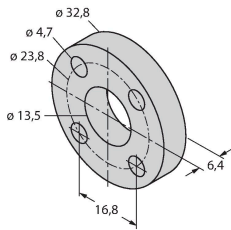

**MB-R10** 6900419

Mounting bracket for sensor head and rod, for external mounting

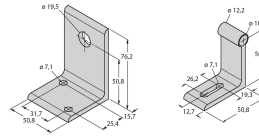

**RB-R10** 6900420

Mounting bracket for rod, for external mounting

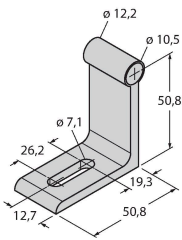

**MMB-R10** 6900004

Mounting bracket for positioning element, for external mounting

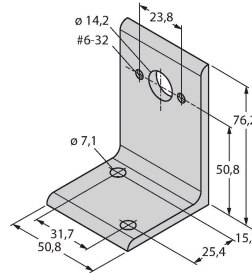

## Accessories

Dimension drawing	Type	ID	
	RKC 6T-2/S618	U5311-51	Connection cable, M12 female connector, straight, 6-pin, cable length: 2 m, jacket material: PVC, gray; cable with foil shield, drain wire not connected to coupling nut, other cable lengths and versions available, see <a href="http://www.turck.com">www.turck.com</a>
	RKC6T-2/TXL	6627031	Connection cable, M12 female connector, straight, 6-pin, cable length: 2 m, jacket material: PUR, black; cULus approval; other cable lengths and versions available, see <a href="http://www.turck.com">www.turck.com</a>