

DTNI20U-M30-AP4X2

Inductive Sensor – Rotation speed monitor

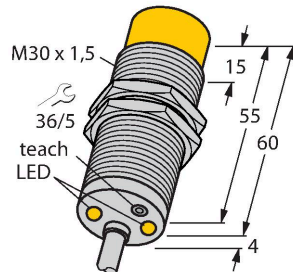

Features

- M30 × 1.5 threaded tube
- Chrome-plated brass
- Large monitoring range of 3 to 3000 1/min
- Adjustable via pushbutton [T]
- Fixed start-up time delay 5 s
- Resistant to magnetic fields
- DC 3-wire, 10...65 VDC
- NO contact, PNP output
- Cable connection

Wiring diagram

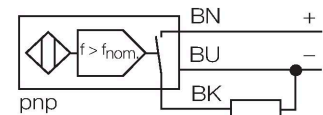

Technical data

Type	DTNI20U-M30-AP4X2
ID	1582232
General data	
Rotational speed range, adjustable	0.05...50 Hz
	adjustable via button
Hysteresis (rotational-speed range)	3...15 %
Rated switching distance	20 mm
Mounting conditions	Non-flush
Secured operating distance	≤ (0.81 × S _n) mm
Repeat accuracy	≤ 2 % of full scale
Temperature drift	≤ ±10 %
	≤ ± 15 %, ≤ -25 °C v ≥ +70 °C
Hysteresis	3...15 %
Electrical data	
Operating voltage U _B	10...65 VDC
Ripple U _{ss}	≤ 10 % U _{Bmax}
DC rated operating current I _e	≤ 200 mA
No-load current	≤ 20 mA
Residual current	≤ 0.1 mA
Isolation test voltage	0.5 kV
Short-circuit protection	yes/Cyclic
Voltage drop at I _e	≤ 1.8 V
Wire break/reverse polarity protection	yes/Complete
Output function	3-wire, NO contact, PNP
Insulation class	□
Mechanical data	
Design	Threaded barrel, M30 x 1.5

Functional principle

The rotational speed is detected by periodic damping of the integrated inductive sensor. This can be accomplished via metal targets or teeth on the monitored shaft. The pulse sequence generated is compared to an adjustable reference value in a comparator circuit. If the rotational speed is below the reference value, the output is switched off (0). If the reference value is exceeded, the output is switched on (1). The start-up time delay (AÜ) is triggered by applying voltage to the device and closes the output for 5 s (start-up time of the drive).

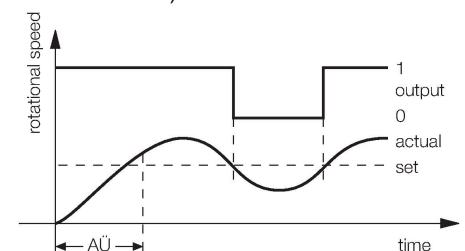

Technical data

Dimensions	64 mm
Housing material	Metal, CuZn, Chrome-plated
Active area material	Plastic, PBT
End cap	Plastic, EPTR
Max. tightening torque of housing nut	75 Nm
Electrical connection	Cable
Cable quality	Ø 5.2 mm, LifYY, PVC, 2 m
Core cross-section	3 x 0.34 mm ²
Environmental conditions	
Ambient temperature	-30...+85 °C
Vibration resistance	55 Hz (1 mm)
Shock resistance	30 g (11 ms)
Protection class	IP67
MTTF	874 years acc. to SN 29500 (Ed. 99) 40 °C
Power-on indication	LED, Green
Switching state	LED, Green/yellow/red/blue

Mounting instructions

Mounting instructions/Description

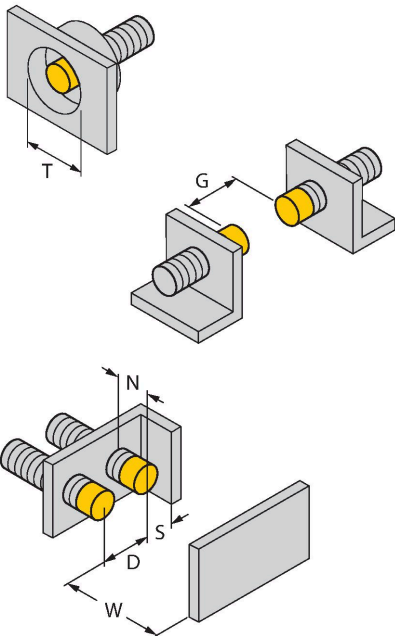

Distance D	3 x B
------------	-------

Distance W	3 x Sn
------------	--------

Distance T	3 x B
------------	-------

Distance S	1.5 x B
------------	---------

Distance G	6 x Sn
------------	--------

Distance N	2 x Sn
------------	--------

Diameter active area B	Ø 30 mm
------------------------	---------

Accessories

BST-30B

6947216

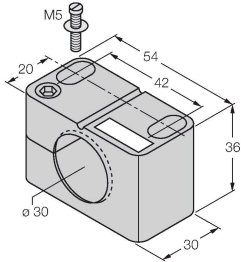

Mounting clamp for threaded barrel sensors, with dead-stop; material: PA6

QM-30

6945103

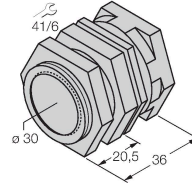

Quick-mount bracket with dead-stop; material: Chrome-plated brass. Male thread M36 × 1.5. Note: The switching distance of the proximity switches may change when using quick-mount brackets.

MW30

6945005

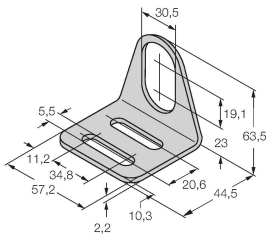

Mounting bracket for threaded barrel sensors; material: Stainless steel A2 1.4301 (AISI 304)

BSS-30

6901319

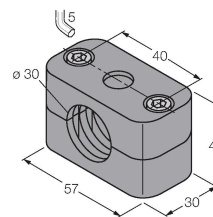

Mounting clamp for smooth and threaded barrel sensors; material: Polypropylene