

# BI5U-Q08-AP6X2-V1131

## Inductive Sensor

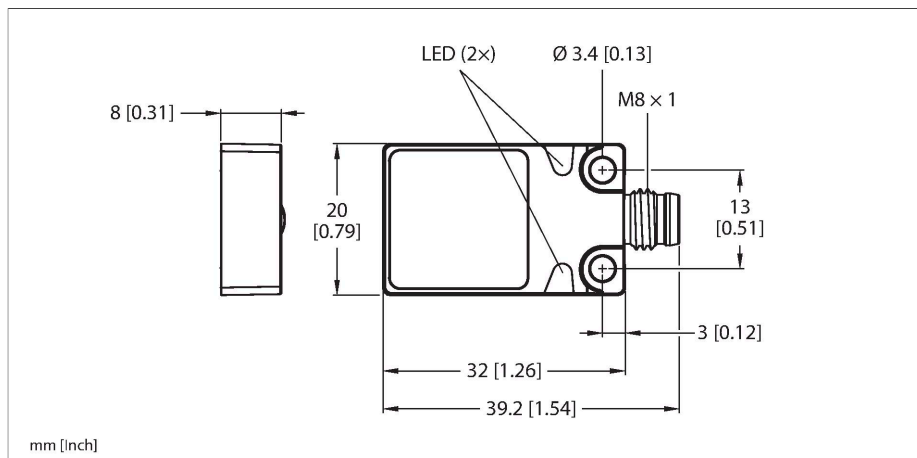

### Technical data

Type	BI5U-Q08-AP6X2-V1131
ID	1608900
<b>General data</b>	
Rated switching distance	5 mm
Mounting conditions	Flush
Secured operating distance	$\leq (0.81 \times S_n)$ mm
Repeat accuracy	$\leq 2\%$ of full scale
	$\leq \pm 15\%$ , $\leq -25\text{ °C}$ v $\geq +70\text{ °C}$
Hysteresis	3...15 %
<b>Electrical data</b>	
Operating voltage	10...30 VDC
Residual ripple	$\leq 10\%$ $U_{ss}$
DC rated operational current	$\leq 200$ mA
No-load current	15 mA
Residual current	$\leq 0.1$ mA
Isolation test voltage	$\leq 0.5$ kV
Short-circuit protection	yes / Cyclic
Voltage drop at $I_o$	$\leq 1.8$ V
Wire breakage/Reverse polarity protection	yes / Complete
Output function	3-wire, NO contact, PNP
DC field stability	300 mT
AC field stability	300 mT <sub>ss</sub>
Switching frequency	0.25 kHz
<b>Mechanical data</b>	
Design	Rectangular, Q08
Dimensions	32 x 20 x 8 mm

### Features

- Rectangular, height 8 mm
- Active face on top
- Metal, Zamak, nickel-plated
- Factor 1 for all metals
- Protection class IP68
- Resistant to magnetic fields
- Extended temperature range
- High switching frequency
- DC 3-wire, 10...30 VDC
- NO contact, PNP output
- Male connector M8 x 1/Ø 8 mm

### Wiring diagram

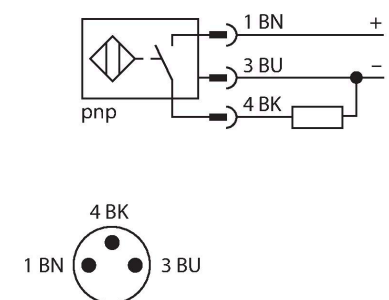

### Functional principle

Inductive sensors are designed for wear-free and contactless detection of metal objects. Approx Factor 1 sensors have significant advantages due to their patented ferrite-coreless multi-coil system. They detect all metals at the same large switching distance and are resistant to magnetic fields.

## Technical data

Housing material	Metal, Zamak, Nickel Plated
Active area material	Plastic, PP, yellow
Electrical connection	Connector, M8 × 1/Ø 8 mm
<b>Environmental conditions</b>	
Ambient temperature	-30...+85 °C
Vibration resistance	55 Hz (1 mm)
Shock resistance	30 g (11 ms)
Protection class	IP68
MTTF	874 years acc. to SN 29500 (Ed. 99) 40 °C
Power-on indication	LED, Green
Switching state	LED, Yellow

## Mounting instructions

Mounting instructions/Description		
	Distance D	40 mm
	Distance W	15 mm
	Distance S	1 × B
	Distance G	30 mm
	Width active area B	20 mm

## Accessories

Dimension drawing	Type	ID	
	PKG3S-2/TEL	6627330	Connection cable, Ø 8-mm female connector, snap-on, straight, 3-pin, cable length: 2 m, jacket material: PVC, black; cULus approval