

RU100U-M18MS-LFX-H1151

Ultrasonic Sensor – Diffuse Mode Sensor

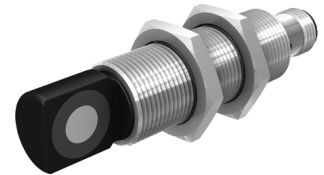
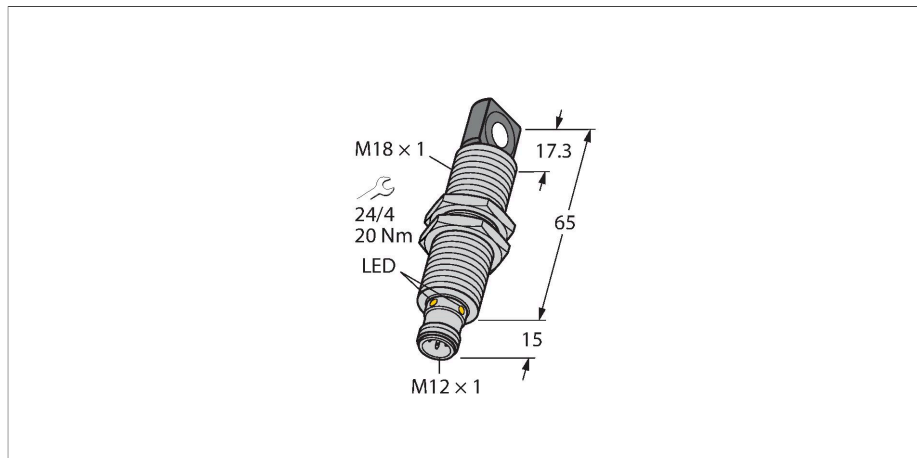

Technical data

Type	RU100U-M18MS-LFX-H1151
ID	1610020
Ultrasonic data	
Function	Proximity switch
Range	150...1000 mm
Resolution	1 mm
Minimum measuring range	100 mm
Ultrasound frequency	200 kHz
Repeat accuracy	≤ 0.15 % of full scale
Temperature drift	± 1.5 % of full scale
Linearity error	≤ ± 0.5 %
Edge lengths of the nominal actuator	100 mm
Approach speed	≤ 8 m/s
Pass speed	≤ 2 m/s
Electrical data	
Operating voltage	15...30 VDC
Residual ripple	10 % U _{ss}
DC rated operational current	≤ 150 mA
Residual current	≤ 0.1 mA
Response time typical	< 90 ms
Readiness delay	≤ 300 ms
Output function	Frequency
Switching frequency	≤ 6.9 Hz
Short-circuit protection	yes / Cyclic
Reverse polarity protection	yes
Wire breakage protection	yes
Setting option	Remote Teach

Features

- Rectangular transducer front
- Cylindrical housing M18, potted
- Connection via M12 x 1 male
- Temperature compensation
- Blind zone: 15 cm
- Range: 100 cm
- Resolution: 1 mm
- Aperture angle of sonic cone: ±16 °
- Frequency output 300...2000 Hz (150...1000 Hz)
- Frequency range selectable via FS control line (see functional principle)

Wiring diagram

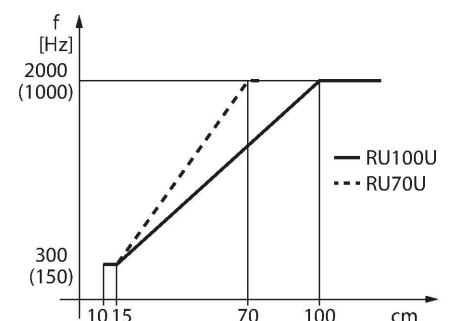
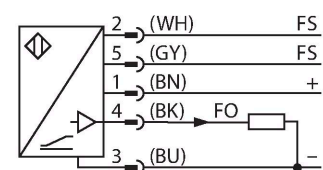

Functional principle

Ultrasonic sensors capture a multitude of objects contactless and wear-free with ultrasonic waves. It does not matter whether the object is transparent or opaque, metallic

Technical data

Mechanical data	
Design	Threaded barrel, M18
Radiation direction	side
Dimensions	Ø 18 x 80 mm
Housing material	Metal, CuZn, Nickel Plated
Max. tightening torque of housing nut	20 Nm
Transducer material	Plastic, Epoxyd resin and PU foam
Electrical connection	Connector, M12 × 1, 5-wire
Ambient temperature	-25...+70 °C
Storage temperature	-40...+80 °C
Pressure resistance	0.5...5 bar
Protection class	IP67
Switching state	LED, Yellow
Object detected	LED, Green
Tests/approvals	
MTTF	281 years acc. to SN 29500 (Ed. 99) 40 °C
Declaration of conformity EN ISO/IEC	EN 60947-5-7
Vibration resistance	IEC 60068-2
Approvals	CE cULus

or non-metallic, firm, liquid or powdery. Even environmental conditions such as spray, dust or rain hardly affect their function. The frequency range can be selected via the control input. If this is connected to ground (-), the lower frequency range is selected. If it is not connected to ground or connected to the supply voltage, the output works in the higher frequency range.

Sonic Cone

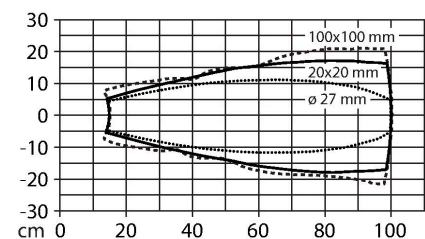

Mounting instructions

Mounting instructions/Description

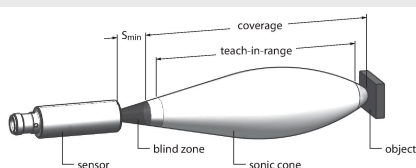

Accessories

MW-18

6945004

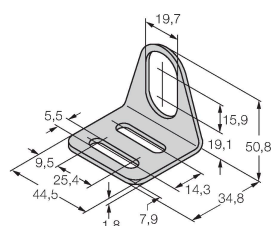

Mounting bracket for threaded barrel sensors; material: Stainless steel A2 1.4301 (AISI 304)

Accessories

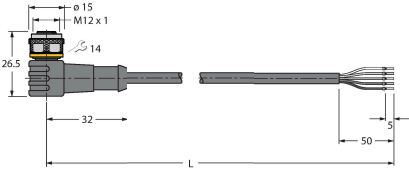
Dimension drawing	Type	ID	
	RKC4.5T-2/TEL	6625016	Connection cable, M12 female connector, straight, 5-pin, cable length: 2 m, jacket material: PVC, black; cULus approval
	WKC4.5T-2/TEL	6625028	Connection cable, M12 female connector, angled, 5-pin, cable length: 2 m, jacket material: PVC, black; cULus approval

Accessories

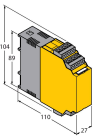
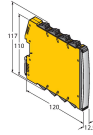
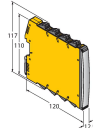
Dimension drawing	Type	ID	
	IM21-14-CDTRI	7505650	Rotation speed monitor with display indication, freely parametrizable monitoring functions, start-up bypass, interlock function, pulse output, current output
	IM12-FI01-2SF-2I-C0/24VDC	7580229	
	IM12-FI01-1SF-1I1R-C0/24VDC	7580225	