

# RU300U-M30E-LIU2PN8X2T-H1151

## Ultrasonic Sensor – Diffuse Mode Sensor

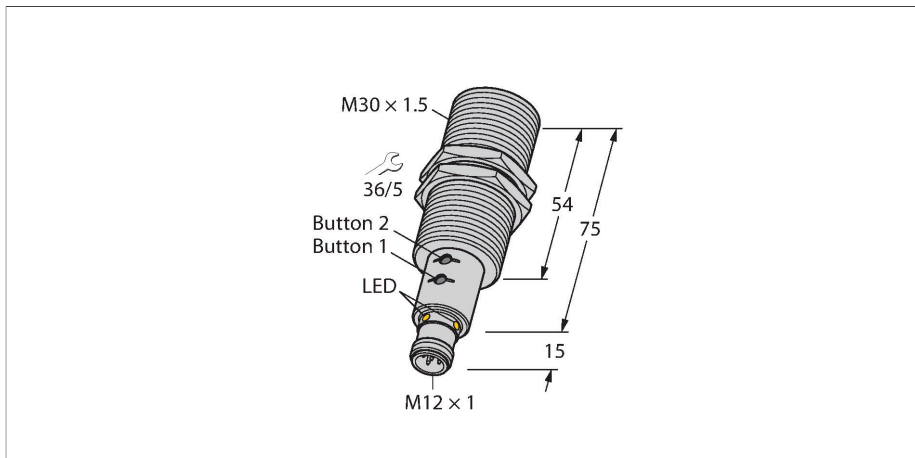

### Technical data

Type	RU300U-M30E-LIU2PN8X2T-H1151
ID	1610048
<b>Ultrasonic data</b>	
Function	Proximity switch
Range	300...3000 mm
Resolution	1 mm
Minimum measuring range	250 mm
Minimum switching range	25 mm
Ultrasound frequency	120 kHz
Repeat accuracy	≤ 0.15 % of full scale
Temperature drift	± 1.5 % of full scale
Linearity error	≤ ± 0.5 %
Edge lengths of the nominal actuator	100 mm
Approach speed	≤ 11 m/s
Pass speed	≤ 4.2 m/s
<b>Electrical data</b>	
Operating voltage	15...30 VDC
Residual ripple	10 % U <sub>ss</sub>
DC rated operational current	≤ 150 mA
No-load current	≤ 50 mA
Load resistance	≤ 1000 Ω
Residual current	≤ 0.1 mA
Response time typical	< 190 ms
Readiness delay	≤ 300 ms
Communication protocol	IO-Link
Output function	NO/NC, PNP/NPN, analog output
Output 1	Switching output or IO-Link mode

### Features

- Smooth sonic transducer face
- Cylindrical housing M30, potted
- Connection via M12 x 1 male
- Measuring range adjustable via teach button/Easy-Teach
- Temperature compensation
- Blind zone: 30 cm
- Range: 300 cm
- Resolution: 1 mm
- Aperture angle of sonic cone: ±15 °
- 1 × switching output, PNP/NPN
- 1 × analog output, 4...20 mA / 0...10 V / additional switching output, PNP/NPN
- NO/NC programmable
- Transmission of process value and parametrization via IO-link

### Wiring diagram

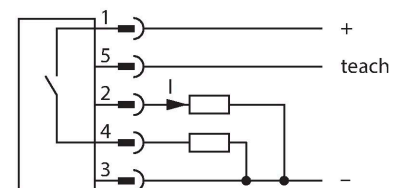

### Functional principle

Ultrasonic sensors capture a multitude of objects contactlessly and wear-free with ultrasonic waves. It does not matter whether the object is transparent or opaque, metallic or non-metallic, firm, liquid or powdery. Even environmental conditions such as spray, dust or rain hardly affect their function. The sonic cone diagram indicates the detection range of the sensor. In accordance with standard EN 60947-5-7, quadratic targets in a range of sizes (20 × 20 mm, 100 × 100 mm) and a round rod with a diameter of 27 mm are used.

## Technical data

Output 2	Analog output
Current output	4...20 mA
Load resistance current output	≤ 0.5 kΩ
Voltage output	0...10 V
Load resistance voltage output	≥ 1 kΩ
Switching frequency	≤ 3.3 Hz
Hysteresis	≤ 25 mm
Voltage drop at I <sub>e</sub>	≤ 2.5 V
Short-circuit protection	yes / Cyclic
Reverse polarity protection	yes
Wire breakage protection	yes
Setting option	Push Button Remote Teach IO-Link
<b>IO-Link</b>	
IO-Link specification	V 1.1
IO-Link port type	Class A
Communication mode	COM 2 (38.4 kBaud)
Process data width	16 bit
Measured value information	15 bit
Switchpoint information	1 bit
Frame type	2.2
Minimum cycle time	2 ms
Function pin 4	IO-Link
Function Pin 2	DI
Maximum cable length	20 m
Profile support	Smart Sensor Profile
Included in the SIDI GSDML	Yes
<b>Mechanical data</b>	
Design	Threaded barrel, M30
Radiation direction	straight
Dimensions	Ø 30 x 89 mm
Housing material	Metal, CuZn, Nickel Plated
Max. tightening torque of housing nut	75 Nm
Transducer material	Plastic, Epoxyd resin and PU foam
Electrical connection	Connector, M12 × 1, 5-wire
Ambient temperature	-25...+70 °C
Storage temperature	-40...+80 °C
Pressure resistance	0.5...5 bar
Protection class	IP67
Switching state	LED, Yellow
Object detected	LED, Green

Important: The detection ranges for other targets may differ from those for standard targets due to the different reflection properties and geometries.

## Sonic Cone

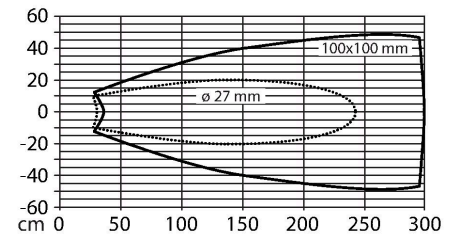

## Technical data

Tests/approvals	
MTTF	191 years acc. to SN 29500 (Ed. 99) 40 °C
Declaration of conformity EN ISO/IEC	EN 60947-5-7
Vibration resistance	IEC 60068-2
Approvals	CE cULus

## Mounting instructions

### Mounting instructions/Description

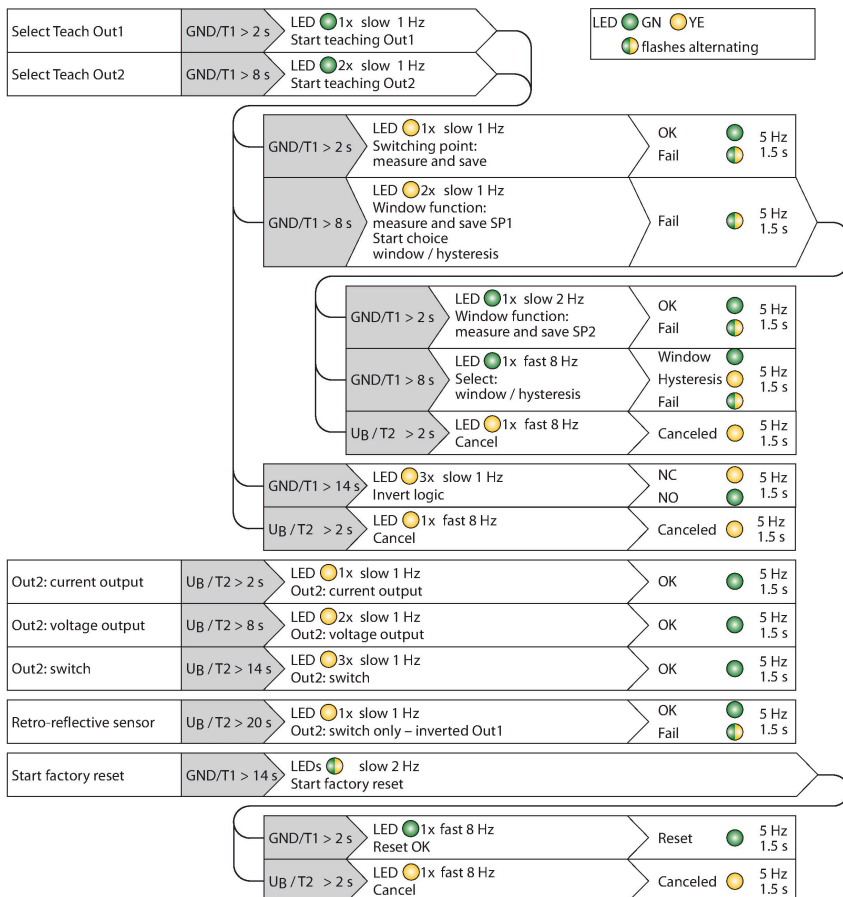
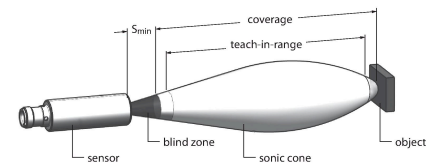

### Setting the limit values

The ultrasonic sensor can be parameterized in such a way that you can either set a teachable measuring and switching range via an analog and a switching output, or switching ranges via two switching outputs. These settings are done with the Easy-Teach adapter or with the buttons at the sensor. The green and yellow LEDs indicate whether the sensor has detected the object.

Various functions such as single switchpoint, window mode or reflection mode to a fixed target can be taught. Further information is described in the operating instructions. How to set the window mode by teaching two limits is described below. These two limits form the switching window and can be selected freely within the detection range.

### Easy-Teach

- Connect the teach adapter TX1-Q20L60 between the sensor and connection cable
- Position object for the first limit value
- Press and hold the select button for output 1 or 2 for 2 or 8 s against Gnd
- Press and hold the select button for 8 s against Gnd to teach the first limit value
- Position object for the second limit value
- Press and hold button for at least 2 s against Gnd

### Teach button

- Position object for the first limit value
- Press and hold button 1 to select output 1 or 2 for 2 or 8 s against Gnd
- Press and hold button 1 for at least 8 s
- Position object for the second limit value
- Press and hold button 1 for at least 2 s

### LED response

Successful teaching is indicated by a fast flashing green LED. The sensor then automatically runs in normal operating mode. Unsuccessful teach-in is indicated by the LED flashing alternately green and yellow. In normal operating mode, both LEDs signal the switching state of output 1.

- Green: Object is within the detection range but not in the switching range
- Yellow: Object is within the switching range
- Off: Object is outside the detection range or signal loss

Accessories

MW-30

6945005

Mounting bracket for threaded barrel sensors; material: Stainless steel A2 1.4301 (AISI 304)

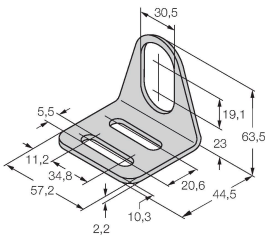

Accessories

Dimension drawing	Type	ID	
-------------------	------	----	--

RKC4.5T-2/TEL

6625016

Connection cable, M12 female connector, straight, 5-pin, cable length: 2 m, jacket material: PVC, black; cULus approval



WKC4.5T-2/TEL

6625028

Connection cable, M12 female connector, angled, 5-pin, cable length: 2 m, jacket material: PVC, black; cULus approval

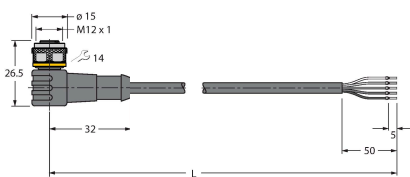

Accessories

Dimension drawing	Type	ID	
-------------------	------	----	--

USB-2-IOL-0002

6825482

IO-Link Master with integrated USB port



TX1-Q20L60

6967114

Teach adapter for inductive encoders, linear position, angle, ultrasonic and capacitive sensors

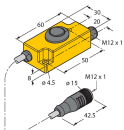

BL67-4IOL

6827386

4-channel IO-Link Master module for the modular BL67 I/O-system

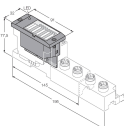

BL20-E-4IOL

6827385

IO-Link master module for the modular BL20 I/O system, 4-channel

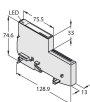

TBEN-S2-4IOL

6814024

Compact multiprotocol I/O module, 4 IO-Link Master 1.1 Class A, 4 universal PNP digital channels 0.5 A

