

BI4U-EM12WD-VP6X-H1141/3GD

Inductive Sensor – For the Food Industry

Features

- Threaded barrel, M12 x 1
- Stainless steel, 1.4404
- Front cap made of liquid crystal polymer
- Factor 1 for all metals
- Resistant to magnetic fields
- For temperatures of -40 °C...+100 °C
- High protection class IP69K for harsh environments
- Special double-lip seal
- Protection against all common acidic and alkaline cleaning agents
- Laser engraved label, permanently legible
- DC 4-wire, 10...30 VDC
- Changeover contact, PNP output
- M12 x 1 male connector
- ATEX category II 3 G, Ex zone 2
- ATEX category II 3 D, Ex zone 22

Wiring diagram

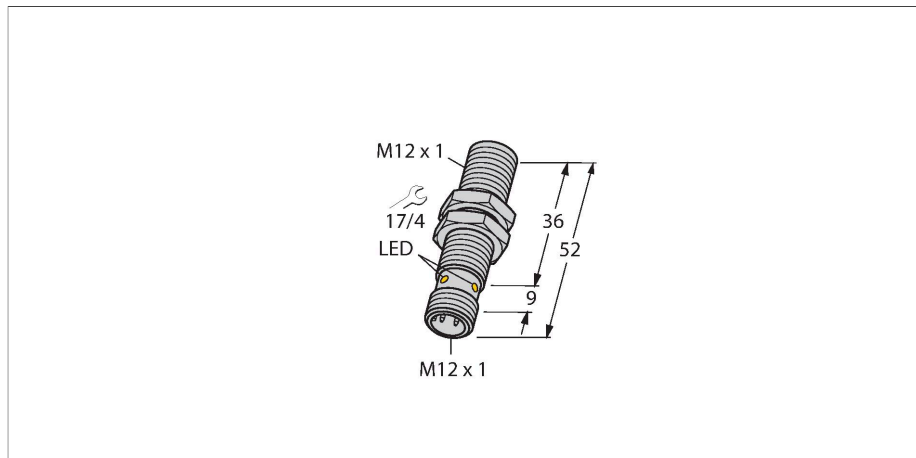
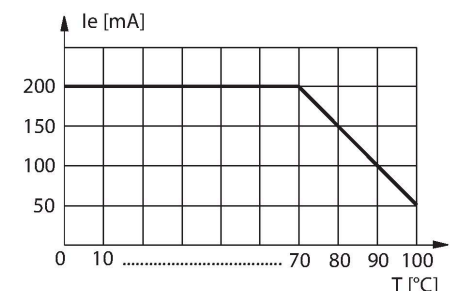
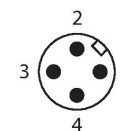
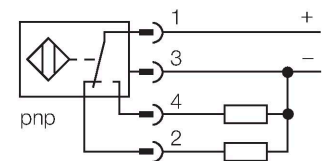

Technical data

Type	BI4U-EM12WD-VP6X-H1141/3GD
ID	1635003
General data	
Rated switching distance	4 mm
Mounting conditions	Flush
Secured operating distance	≤ (0.81 × S _n) mm
Repeat accuracy	≤ 2 % of full scale
Temperature drift	≤ ±10 % ≤ ± 20 %, ≤ -25 °C , ≥ +70 °C
Hysteresis	3...15 %
Electrical data	
Operating voltage	10...30 VDC
Residual ripple	≤ 10 % U _{ss}
DC rated operational current	≤ 200 mA
No-load current	25 mA
Residual current	≤ 0.1 mA
Isolation test voltage	≤ 0.5 kV
Short-circuit protection	yes / Cyclic
Voltage drop at I _e	≤ 1.8 V
Wire breakage/Reverse polarity protection	yes / Complete
Output function	4-wire, Complementary contact, PNP
DC field stability	300 mT
AC field stability	300 mT _{ss}
Insulation class	□
Switching frequency	3 kHz
Approval acc. to	ATEX test certificate TURCK Ex-10002M X

Technical data

Device marking	EX II 3 G Ex ec IIC T4 Gc/II 3 D Ex tc IIIC T110 °C Dc
Warning	Do not unplug connector under voltage
Mechanical data	
Design	Threaded barrel, M12 x 1
Dimensions	52 mm
Housing material	Stainless steel, 1.4404 (AISI 316L)
Active area material	Plastic, LCP
Connector housing	plastic, PP
Admissible pressure on front cap	≤ 20 bar
Max. tightening torque of housing nut	10 Nm
Electrical connection	Connector, M12 × 1
Environmental conditions	
Ambient temperature	-40...+100 °C
	For explosion hazardous areas see instruction leaflet
Vibration resistance	55 Hz (1 mm)
Shock resistance	30 g (11 ms)
Protection class	IP68 IP69K
MTTF	874 years acc. to SN 29500 (Ed. 99) 40 °C
Switching state	LED, Yellow
Included in delivery	SC-M12/3GD

Mounting instructions

Mounting instructions/Description

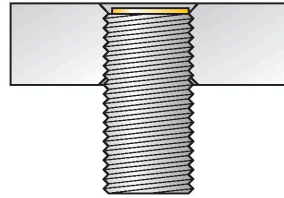
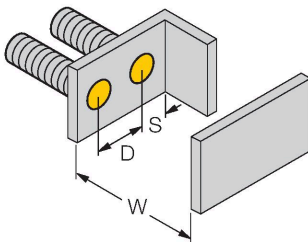
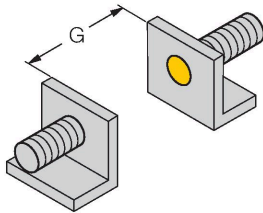
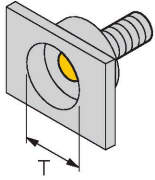

Distance D	24 mm
Distance W	3 x Sn
Distance T	3 x B
Distance S	1.5 x B
Distance G	6 x Sn
Diameter active area B	Ø 12 mm

All flush mountable uprox+ threaded barrel types are also recessed mountable. Safe operation is ensured if the sensor is screwed in by half a turn.

Accessories

MW12

6945003

Mounting bracket for threaded barrel sensors; material: Stainless steel A2 1.4301 (AISI 304)

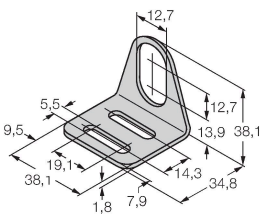

BSS-12

6901321

Mounting clamp for smooth and threaded barrel sensors; material: Polypropylene

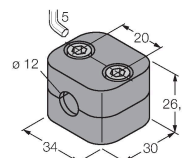

PN-M12

6905309

Impact protection nut for M12x1 threaded barrel devices; material: Stainless steel A2 1.4305 (AISI 303)

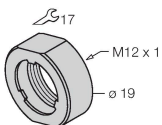

Accessories

Dimension drawing	Type	ID	
	RKH4.4-2/TFE	6934473	Connection cable, M12 female connector, straight, 4-pin, stainless steel coupling nut, cable length: 2 m, jacket material: PVC, gray; temperature range: -25...+80 °C
	RKH4.4-2/TFG	6933086	Connection cable, M12 female connector, straight, 4-pin, stainless steel coupling nut, cable length: 2 m, jacket material: TPE, gray; temperature range: -40...+105 °C

Instructions for use

Intended use	This device fulfills the directive 2014/34/EU and is suited for use in explosion-hazardous areas acc. to EN60079-0:2018, EN60079-7:2015/A1:2018, EN60079-31:2014. In order to ensure correct operation to the intended purpose it is required to observe the national regulations and directives.
For use in explosion hazardous areas conform to classification	II 3 G and II 3 D (Group II, Category 3 G, electrical equipment for gaseous atmospheres and category 3 D, electrical equipment for dust atmospheres).
Marking (see device or technical data sheet)	Ex II 3 G Ex ec IIC T4 Gc acc. to EN 60079-0:2018 and EN 60079-7:2015/A1:2018 and Ex II 3 D Ex tc IIIC T110 °C Dc acc. to EN 60079-0:2018 and EN 60079-31:2014
Local admissible ambient temperature	-25...+70 °C
Installation/Commissioning	These devices may only be installed, connected and operated by trained and qualified staff. Qualified staff must have knowledge of protection classes, directives and regulations concerning electrical equipment designed for use in explosion hazardous areas. Please verify that the classification and the marking on the device comply with the actual application conditions.
Installation and mounting instructions	Avoid static charging of cables and plastic devices. Please only clean the device with a damp cloth. Do not install the device in a dust flow and avoid build-up of dust deposits on the device. The devices must be protected against strong magnetic fields. The pin configuration and the electrical specifications can be taken from the device marking or the technical data sheet. In order to avoid contamination of the device, please remove possible blanking plugs of the cable glands or connectors only shortly before inserting the cable or opening the cable socket.
Special conditions for safe operation	For devices with M12 connectors please use the supplied safety clip SC-M12/3GD. Do not disconnect the plug-in connection or cable under voltage. Please attach a warning label permanently in an appropriate fashion in close proximity to the plug-in connection with the following inscription: Nicht unter Spannung trennen / Do not separate when energized. The device must be protected against any kind of mechanical damage and degrading UV-radiation. The IP protection rating of the connectors is given only in combination with a suitable O-ring. Load voltage and operating voltage of this equipment must be supplied from power supplies with safe isolation (IEC 30 364/UL508), to ensure that the rated voltage of the equipment (24 VDC +20% = 28.8 VDC) is never exceeded by more than 40%.
Service/Maintenance	Repairs are not possible. The approval expires if the device is repaired or modified by a person other than the manufacturer. The most important data from the approval are listed.