

BI15U-MT30-AP6X-H1141/S1589

Inductive Sensor – With WeldGuard™ Coating

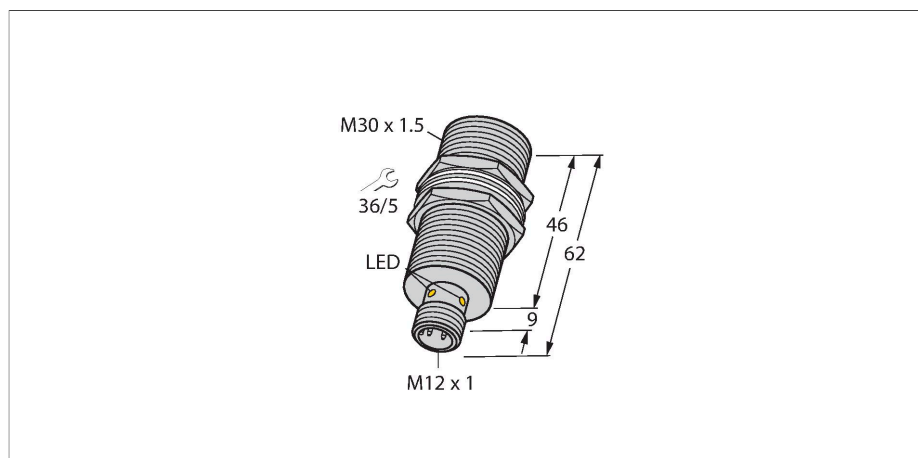

Technical data

Type	BI15U-MT30-AP6X-H1141/S1589
ID	1636793
Special version	S1589 corresponds to: With WeldGuard™ Coating
General data	
Rated switching distance	15 mm
Mounting conditions	Flush
Secured operating distance	$\leq (0.81 \times S_n)$ mm
Repeat accuracy	$\leq 2\%$ of full scale
Temperature drift	$\leq \pm 10\%$
Hysteresis	3...15 %
Electrical data	
Operating voltage	10...30 VDC
Residual ripple	$\leq 10\% U_{ss}$
DC rated operational current	≤ 200 mA
No-load current	25 mA
Residual current	≤ 0.1 mA
Isolation test voltage	≤ 0.5 kV
Short-circuit protection	yes / Cyclic
Voltage drop at I_o	≤ 1.8 V
Wire breakage/Reverse polarity protection	yes / Complete
Output function	3-wire, NO contact, PNP
DC field stability	300 mT
AC field stability	300 mT _{ss}
Insulation class	□
Switching frequency	1 kHz

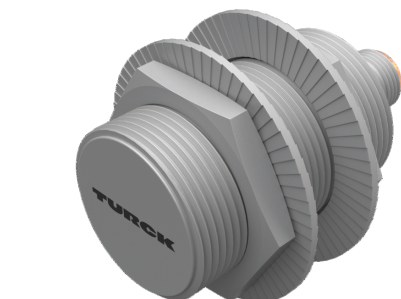

Features

- M30 × 1.5 threaded barrel
- Brass, PTFE-coated
- Front cap with special coating, very resistant to thermal and mechanical load
- Factor 1 for all metals
- Protection class IP68
- Resistant to magnetic fields
- Large switching distance
- Recessed mountable
- DC 3-wire, 10...30 VDC
- NO contact, PNP output
- M12 x 1 male connector

Wiring diagram

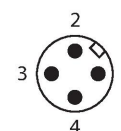
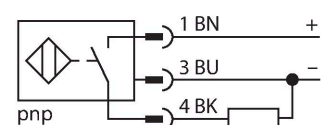

Functional principle

Inductive sensors are designed for wear-free and contactless detection of metal objects. apox+ sensors have significant advantages due to their patented multi-coil system. They excel thanks to their optimum switching distances, maximum flexibility and operational reliability as well as efficient standardization.

Technical data

Mechanical data	
Design	Threaded barrel, M30 x 1.5
Dimensions	62 mm
Housing material	Metal, CuZn, PTFE-coated
Active area material	Plastic, LCP, PTFE-coated
Max. tightening torque of housing nut	75 Nm
Electrical connection	Connector, M12 x 1
Environmental conditions	
Ambient temperature	-30...+85 °C
Vibration resistance	55 Hz (1 mm)
Shock resistance	30 g (11 ms)
Protection class	IP68
MTTF	874 years acc. to SN 29500 (Ed. 99) 40 °C
Switching state	LED, Yellow

Mounting instructions

Mounting instructions/Description

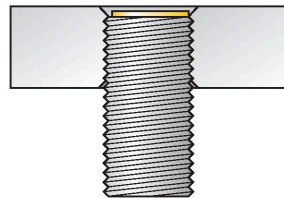

Distance D	60 mm
Distance W	3 x Sn
Distance T	3 x B
Distance S	1.5 x B
Distance G	6 x Sn
Diameter active area B	Ø 30 mm

All flush mountable uprox+ threaded barrel types are also recessed mountable. Safe operation is ensured if the sensor is screwed in by half a turn.

Accessories

BST-30B

6947216

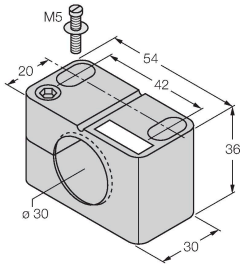

Mounting clamp for threaded barrel sensors, with dead-stop; material: PA6

QMT-30

6945105



Quick-mount bracket with dead-stop; material: brass, PTFE-coated; Male thread M36 × 1.5. Note: The switching distance of the proximity switches may change when using quick-mount brackets.

BSS-30

6901319

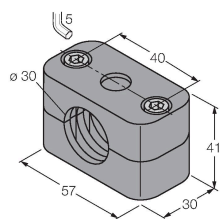

Mounting clamp for smooth and threaded barrel sensors; material: Polypropylene

PN-M30

6905308

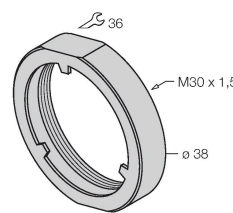

Protective nut for M30 × 1 threaded barrel devices; material: Stainless steel A2 1.4305 (AISI 303)

Accessories

Dimension drawing

Type

ID

RKC4T-2/TXL1001

6630249

Connection cable, M12 female connector, straight, 3-pin, cable length: 2 m, protective jacket material: aramid fibers, yellow; temperature peak: 200 °C

