

S18UIA

Ultrasonic Sensor – diffuse mode sensor With Analog Output

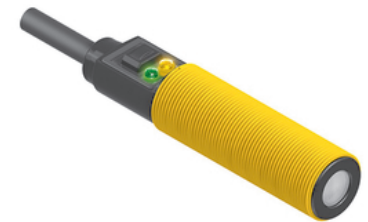
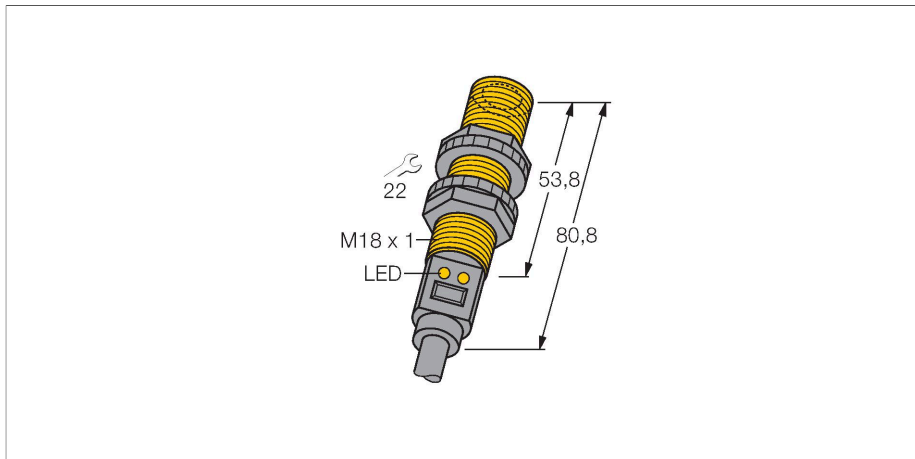

Technical data

Type	S18UIA
ID	3002702
Ultrasonic data	
Function	Proximity switch
Range	30...300 mm
Ultrasound frequency	300 kHz
Repeatability	≤ ± 0.25 mm
Temperature drift	± 0.3 % of full scale
Edge lengths of the nominal actuator	50 mm
Electrical data	
Operating voltage	10...30 VDC
No-load current	≤ 100 mA
Load resistance	≤ 1000 Ω
Response time typical	< 2.5 ms
Readiness delay	≤ 300 ms
Output function	Analog output
Current output	4...20 mA
Short-circuit protection	yes
Reverse polarity protection	Complete
Wire breakage protection	yes
Mechanical data	
Design	Tube, S18U
Radiation direction	straight
Dimensions	Ø 18 x 80.8 mm
Housing material	Plastic, ABS/Polycarbonate

Features

- Compact design
- Cable, 2 m
- Temperature compensation
- Very small blind zone
- Measuring range adjustable via teach-in
- Blind zone: 3 cm
- Range: 30 cm

Wiring diagram

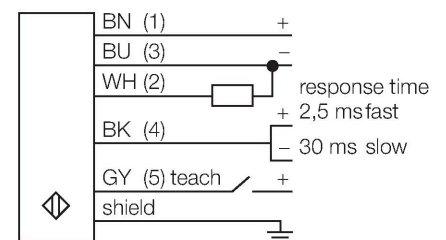

Functional principle

Ultrasonic sensors detect a multitude of objects contactless and wear-free with ultrasonic waves. Regardless of whether the object is transparent or opaque, metallic or non-metallic, liquid, solid or powdery. Even environmental conditions such as spray, dust or rain hardly affect their function.

Technical data

Transducer material	Plastic, Epoxyd resin and PU foam
Electrical connection	Cable, 2 m, PVC
Ambient temperature	-20...+60 °C
Storage temperature	-40...+80 °C
Relative humidity	100 %
Protection class	IP67
Power-on indication	LED
Switching state	LED
Object detected	LED, Green
Tests/approvals	
MTTF	53 years acc. to SN 29500 (Ed. 99) 40 °C
Approvals	CE, cURus

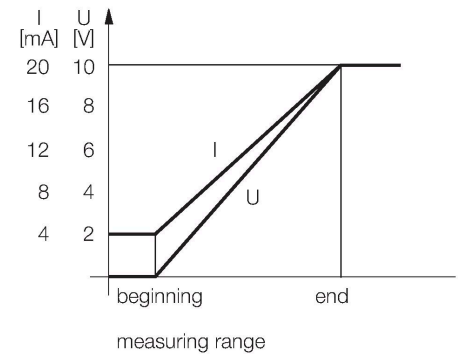

Accessories

SMB18A 3033200

Mounting bracket, rectangular, stainless steel, for sensors with 18 mm thread

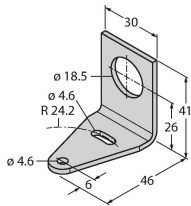

SMB18FM 3079421

mounting bracket, black, M22 x1.5 mm, male thread, female thread M18 x 1, for sensors with 18 mm thread

SMB18SF 3052519

Mounting bracket, PBT black, for sensors with 18 mm thread, rotatable

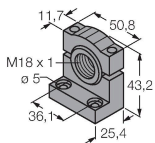

Accessories

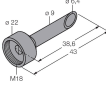
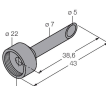
Dimension drawing	Type	ID	
	UWG18-6.4	3076952	Ultrasonic focussing-adapter for QS18U and S18U, internal diameter 6.4 mm
	UWG18-5.0	3077342	Ultrasonic focussing-adapter for QS18U and S18U, internal diameter 5.0 mm