

# QS186LE14

## Photoelectric Sensor – Laser Emitter

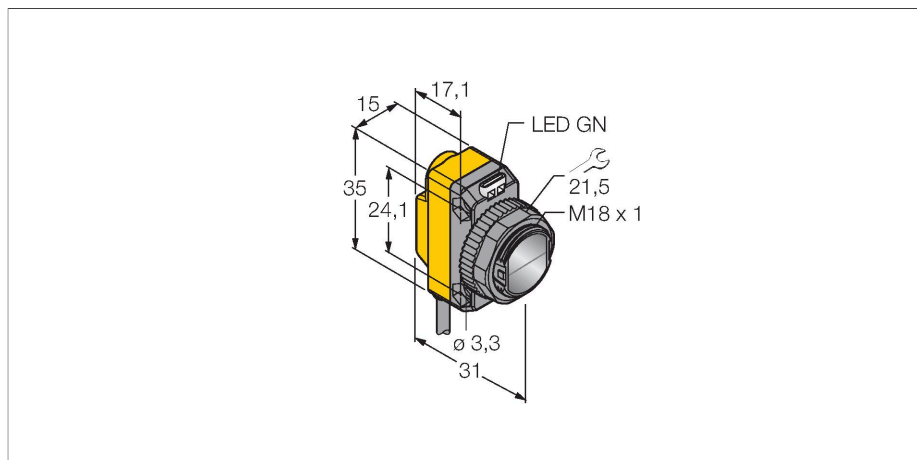

### Technical data

Type	QS186LE14
ID	3002788
<b>Optical data</b>	
Function	Opposed mode sensor
Operating mode	Laser Emitter
Light type	Red
Wavelength	650 nm
Laser class	▲ 1
Range	0...15000 mm
<b>Electrical data</b>	
Operating voltage	10...30 VDC
Residual ripple	< 10 % U <sub>ss</sub>
DC rated operational current	≤ 100 mA
Short-circuit protection	yes
Reverse polarity protection	yes
Readiness delay	≤ 0.25 s
Readiness delay	≤ 250 ms
<b>Mechanical data</b>	
Design	Rectangular with thread, QS18
Dimensions	Ø 18 x 31 x 15 x 35 mm
Housing material	Plastic, ABS
Lens	plastic, PMMA
Electrical connection	Cable, 2 m, PVC
Number of cores	4
Core cross-section	0.35 mm <sup>2</sup>
Ambient temperature	-10...+50 °C
Protection class	IP67

### Features

- Cable, PVC, 2 m
- Protection class IP67
- LED all-round visible
- Operating voltage: 10...30 VDC

### Wiring diagram

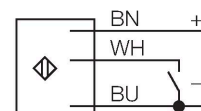

### Functional principle

Opposed mode sensors consist of an emitter and a receiver. They are installed opposite to each other whereby the emitted light aims directly at the receiver. When an object interrupts or weakens the light beam, the sensor switches. Opposed mode sensors are the most reliable photoelectric sensors for detection of opaque objects. The high light/dark contrast and the very high excess gain are typical for this function mode and enable operation over large distances and under difficult conditions.

#### Activation

By connecting the control input (PIN 2 WH) to ground (-) the laser beam is turned on. The laser beam is turned off again by feeding 10 ... 30 VDC to the control input or by non-connecting the wire.

#### Excess gain curve

Excess gain in relation to the distance (type 6EB/RB)

## Technical data

Special features	Laser
Power-on indication	LED, Green
Excess gain indication	LED
<b>Tests/approvals</b>	
MTTF	530 years acc. to SN 29500 (Ed. 99) 40 °C
Approvals	CE

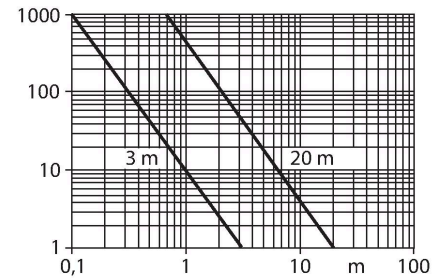

## Accessories

SMB18A

3033200

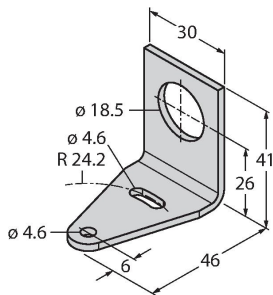

Mounting bracket, rectangular, stainless steel, for sensors with 18 mm thread

SMB18AFAM10

3012558

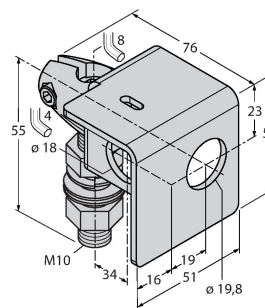

Mounting bracket, material VA 1.4401, for M10 x 1.5 thread, thread length 18 mm

SMBQS18A

3069721

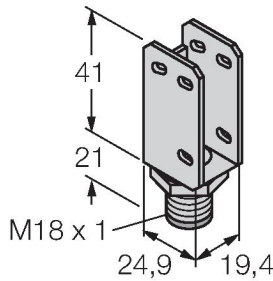

Mounting bracket, stainless steel, for 18 mm thread

SMB18SF

3052519

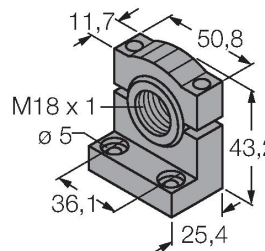

Mounting bracket, PBT black, for sensors with 18 mm thread, rotatable