

LEDBLA290SSD6-XQ

Vision System – Linear Area Light

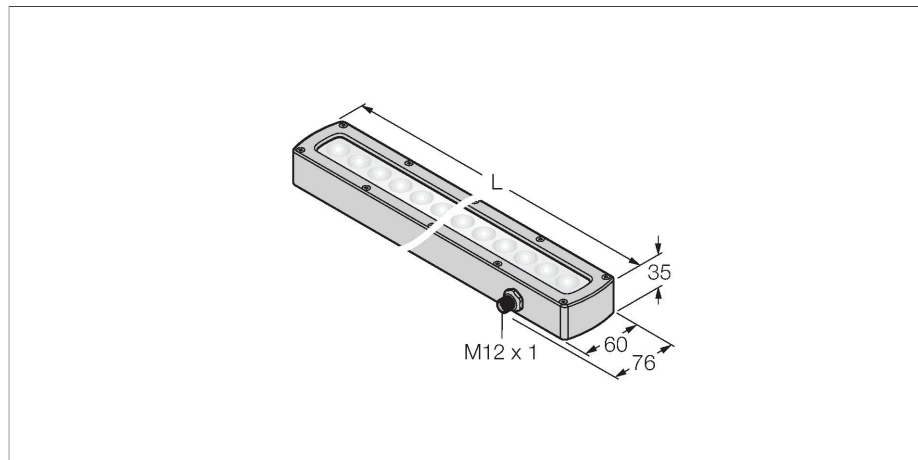

Features

- High-Intensity
- Protection class: IP68
- Color: blue
- Power supply: 24 VDC
- M12 x 1 male

Wiring diagram



Technical data

Type	LEDBLA290SSD6-XQ
ID	3013519
Signal and display data	
Purpose	Image processing
Function	Linear light
Light type	Blue
Wavelength	465...485 nm
Beam angle	6.5°
LED service life (L70)	50000 h
Features of color 1	Blue
Special features	Wash down
Electrical data	
Operating voltage	24 VDC
DC rated operational current	≤ 1000 mA
Max. current consumption per color	1000 mA
Mechanical data	
Design	Rectangular
Dimensions	328 x 76 x 34.9 mm
Housing material	Metal, Stainless steel
Window material	Plastic, diffuse
Electrical connection	Connector, M12 × 1, PVC
Number of cores	5
Ambient temperature	0...+50 °C
Protection class	IP68
Tests/approvals	
Approvals	CE, cULus listed

Functional principle

High-intense illumination of large areas at long distances.

