

LEDGLA145XD6-XQ

Vision System – Linear Area Light

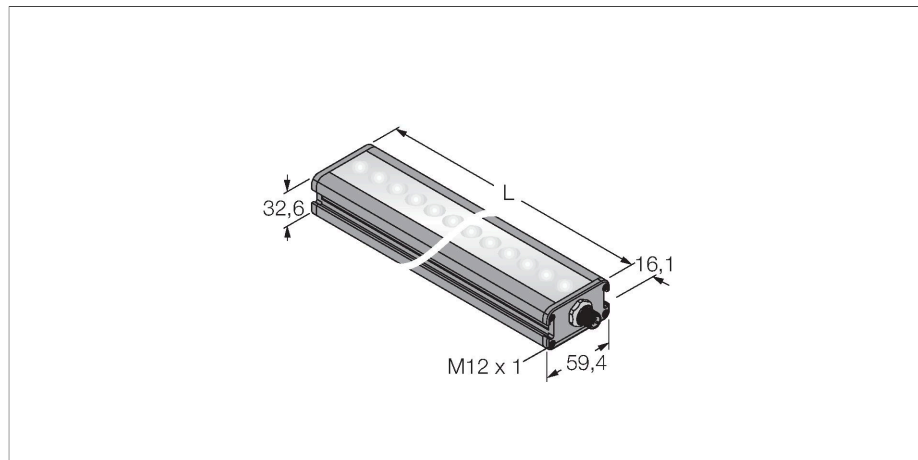

Features

- High-Intensity
- Protection class: IP50
- Color: green
- Power supply: 24 VDC
- M12 x 1 male

Wiring diagram



Technical data

Type	LEDGLA145XD6-XQ
ID	3017054
Signal and display data	
Purpose	Image processing
Function	Linear light
Light type	Green
Wavelength	520...535 nm
Beam angle	6.5°
LED service life (L70)	50000 h
Features of color 1	Green
Special features	Wash down
Electrical data	
Operating voltage	24 VDC
DC rated operational current	≤ 500 mA
Max. current consumption per color	500 mA
Mechanical data	
Design	Rectangular
Dimensions	187.1 x 59.4 x 32.6 mm
Housing material	Metal, Anodized AL
Window material	Plastic, diffuse
Electrical connection	Connector, M12 × 1, PVC
Number of cores	5
Ambient temperature	0...+50 °C
Protection class	IP50
Tests/approvals	
Approvals	CE, cULus listed

Functional principle

High-intense illumination of large areas at long distances.

