

DX80N2X1S-P3E

Radio Transmission System – Star Topology

Node (FlexPower)

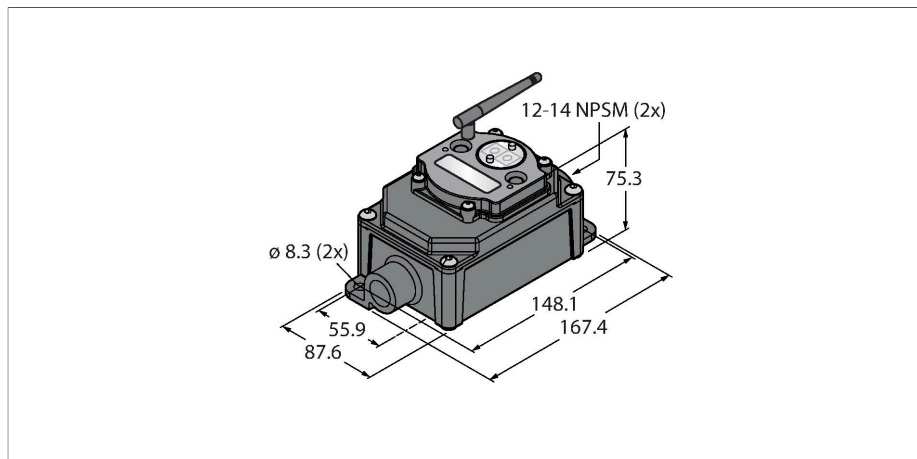

Features

- External antenna (RG58 RP-SMA connection)
- Integrated signal strength indicator
- Configuration via DIP switch
- Deterministic data transfer
- Frequency hopping FHSS
- Time Division Multiplex Access TDMA
- Transmission power: 63 mW, 18 dBm conducted, ≤ 20 dBm EIRP
- Internal battery
- Inputs: 2 x NPN, 4 x thermocouple
- Outputs: 1 x NMOS

Wiring diagram

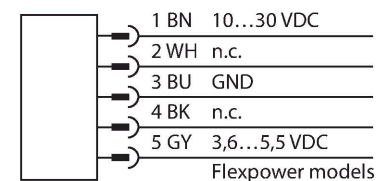

Functional principle

The DX80 system forms a radio-based network for wireless, bidirectional transmission of sensor signals in a star topology. It consists of a gateway that transmits the I/O signals to the control system and to as many as 47 nodes, with each node taking up to 12 sensors/actuators. The system is configured via the gateway with the included software. You can supply different components with DC voltage either via the power grid or self-sufficiently via battery or solar cell. Depending on the type of gateway used, simultaneous transmission of different measured and switching values is possible as well as communication via RS485 interface.

Norms:
 FCC-ID UE300DX80-2400- This device complies with FCC para. 15, subpara. C, 15.247
 ETSI/EN: In compliance with EN 300 328: V2.2.2 (2019-02)
 IC: 7044A-DX8024
 Radiation protection 10 V/m for 80–2700 MHz acc. to EN 61000-6-2
 Shock and vibration resistance: IEC 68-2-6 and IEC 68-2-7

Technical data

Type	DX80N2X1S-P3E
ID	3018091
Wireless data	
Type of radio	short-range
Installation	stationary
Topology	Star topology
Function	Star topology
Device type	Node
Frequency band	2.4-GHz ISM band
Frequency range	2.402 - 2.483 GHz
Number of radio channels	50
Channel width	1 MHz
Spread spectrum technology	FHSS (Frequency Hopping Spread Spectrum)
Single-Carrier Residence Time	7.8 ms
Response time typical	< 1000 ms
Output power ERP	18 dB/65 mW
Output power EIRP	20 dB/100 mW
Range	3200000 mm
I/O data	
Number of channels	2 / 4
Input type	NPN/thermocouple
Number of channels	1
Output type	NMOS
Electrical data	
runs with battery	ja



Technical data

Operating voltage	3.6...5.5 VDC
Power-on indication	LED, Green
Mechanical data	
Design	Rectangular, DX80
Dimensions	127 x 80.8 x 57 mm
Housing material	Plastic, PC
Antenna connection	RP-SMA female connector
Ambient temperature	-40...+85 °C
Relative humidity	0...95 %
Protection class	IP65
Tests/approvals	
Approvals	ATEX II 3 G
Approvals	CE CSA ATEX
Device marking	II 3 G Ex nA IIC T4 Gc
Ex approval acc. to conformity certificate	LCIE 10 ATEX 1012 X

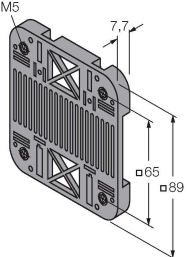
Accessories

SMBDX80DIN	3077161	BWA-BATT-001	3078261
	Mounting panel for DIN rail, suited for CP80, DX80, K80, Q80, operating temperature: -20...90 °C	Keine Maßzeichnung vorhanden! No drawing available!	Lithium-ion battery, D cell, 3.6 VDC, 19,000 mAh, American supplier, GGV UN3090/CL9

Accessories

Dimension drawing	Type	ID	
Keine Maßzeichnung vorhanden! No drawing available!	BWC-LMRSFRPB	3079296	Surge protection, bulkhead fitting, RP-SMA type
	BWC-1MRSFRSB0.2	3078544	Antenna extension, RP-SMA on RP-SMAF bulkhead fitting, 0.2m, RG58, loss 1.05 dB/m
	BWC-1MRSFRSB1	3078337	Antenna extension, RP-SMA on RP-SMAF bulkhead fitting, 1 m, RG58, loss 1.05 dB/m

Dimension drawing	Type	ID	
	BWC-1MRSFRSB2	3078338	Antenna extension, RP-SMA on RP-SMAF bulkhead fitting, 2m, RG58, loss 1.05 dB/m
	BWC-1MRSFRSB4	3077488	Antenna extension, RP-SMA on RP-SMAF bulkhead fitting, 4m, RG58, loss 1.05 dB/m
	BWC-1MRSMN05	3077486	Antenna extension, RP-SMA on N-male, 0.5 m, RG58, loss 0.56 dB/m
	BWC-1MRSMN2	3077820	Antenna extension, RP-SMA on N-male, 2m, RG58, loss 0.56 dB/m
	BWC-4MNFN3	3077489	Antenna extension, N male connector to N female connector, cable length: 3 m, LMR400, coaxial, loss: 0.22 dB/m
	BWC-4MNFN6	3077490	Antenna extension, N-male on N-female, 6m, LMR400, coaxial, loss 0.22 dB/m
	BWC-4MNFN15	3077821	Antenna extension, N-male on N-female, 15 m, LMR400, coaxial, loss 0.22 dB/m
	BWC-4MNFN30	3077822	Antenna extension, N-male on N-female, 30m, LMR400, coaxial, loss 0.22 dB/m

Accessories

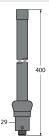
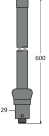
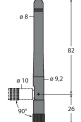
Dimension drawing	Type	ID	
	BWA-2O6-A	3081081	External antenna 6 dBi, N-female
	BWA-2O8-A	3081080	External antenna 8.5 dBi, N-female
	BWA-2O2-C	3077816	Internal antenna 2 dBi, RP-SMA male, standard

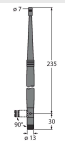
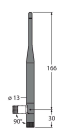
Dimension drawing	Type	ID	
 <p>Technical drawing of the BWA-205-C antenna. It shows a vertical antenna with a total length of 205 mm. The diameter at the top is 7 mm, and the diameter at the bottom is 15 mm. The drawing includes a scale bar and a reference point.</p>	BWA-205-C	3077817	Internal antenna 5 dBi, RP-SMA male
 <p>Technical drawing of the BWA-207-C antenna. It shows a vertical antenna with a total length of 166 mm. The diameter at the top is 13 mm, and the diameter at the bottom is 10 mm. The drawing includes a scale bar and a reference point.</p>	BWA-207-C	3077818	Internal antenna 7 dBi, RP-SMA male