

Radio Transmission System

Star Topology

Node (FlexPower)

DX80N2X1S-P6

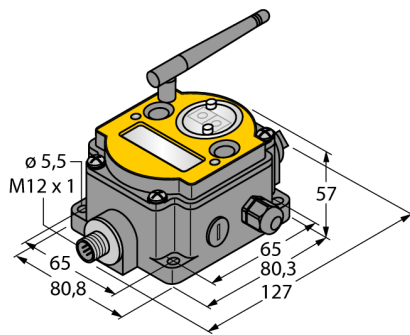

- External antenna (RG58 RP-SMA connection)
- Integrated signal strength indicator
- Configuration via DIP switch
- Deterministic data transfer
- Frequency hopping FHSS
- Time Division Multiplex Access TDMA
- Transmission power: 63 mW, 18 dBm conducted, ≤ 20 dBm EIRP
- Internal battery
- Inputs: Serial interface to connect a sensor

Wiring Diagram

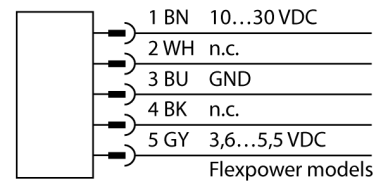

Functional principle

The DX80 system forms a radio-based network for wireless, bidirectional transmission of sensor signals in a star topology. It consists of a gateway that transmits the I/O signals to the control system and to as many as 47 nodes, with each node taking up to 12 sensors/actuators. The system is configured via the gateway with the included software. You can supply different components with DC voltage either via the power grid or self-sufficiently via battery or solar cell. Depending on the type of gateway used, simultaneous transmission of different measured and switching values is possible as well as communication via RS485 interface.

Norms:

FCC-ID UE300DX80-2400- This device complies with FCC para. 15, subpara. C, 15.247
 ETSI/EN: In compliance with EN 300 328: V2.2.2 (2019-02)
 IC: 7044A-DX8024
 Radiation protection 10 V/m for 80–2700 MHz acc. to EN 61000-6-2
 Shock and vibration resistance: IEC 68-2-6 and IEC 68-2-7

Type	DX80N2X1S-P6
ID	3018657
Wireless data	
Type of radio	short-range
Installation	stationary
Topology	Star topology
Function	Star topology
Device type	Node
Frequency band	2.4-GHz ISM band
Frequency range	2.402 - 2.483 GHz
Number of radio channels	50
Channel width	1 MHz
Spread spectrum technology	FHSS (Frequency Hopping Spread Spectrum)
Single-Carrier Residence Time	7.8 ms
Response time typical	< 1000 ms
Output power ERP	18 dB/65 mW
Output power EIRP	20 dB/100 mW
I/O data	
Number of channels	1
Input type	Serial interface
Communication protocol	1-wire-serial
Electrical data	
Runs with battery	Yes
Operating voltage U _s	3.6...5.5 VDC
Power-on indication	LED, Green
Mechanical data	
Design	Rectangular, DX80
Housing material	Plastic, PC
Antenna connection	RP-SMA female connector
Ambient temperature	-40...+85 °C
Relative humidity	0...95%
Protection class	IP67

Tests/approvals

Approvals

ATEX II 3 G

Accessories

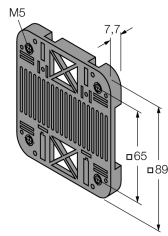
Type code	Ident no.		Dimension drawing
SMBDX80DIN	3077161	Mounting panel for DIN rail, suited for CP80, DX80, K80, Q80, operating temperature: -20...90 °C	 <p>M5 7,7 ø65 ø89</p>
BWA-BATT-001	3078261	Lithium-ion battery, D cell, 3.6 VDC, 19,000 mAh, American supplier, GGV UN3090/CL9	<p>Keine Maßzeichnung vorhanden! No drawing available!</p>

Function accessories

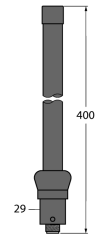
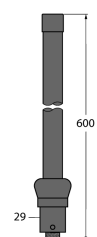
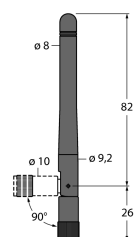
Type code	Ident no.		Dimension drawing
BWA-2O6-A	3081081	External antenna 6 dBi, N-female	 <p>400 29</p>
BWA-2O8-A	3081080	External antenna 8.5 dBi, N-female	 <p>600 29</p>
BWA-2O2-C	3077816	Internal antenna 2 dBi, RP-SMA male, standard	 <p>ø 8 82 ø 10 ø 9,2 26 90°</p>

Function accessories

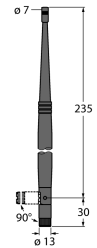
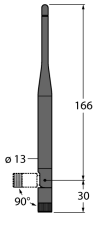
Type code	Ident no.		Dimension drawing
BWA-205-C	3077817	Internal antenna 5 dBi, RP-SMA male	 <p>Technical drawing of the BWA-205-C antenna. It shows a vertical antenna with a total height of 235 mm. The top section has a diameter of 7 mm. The bottom section has a diameter of 13 mm. The antenna is shown at a 90-degree angle to the mounting surface.</p>
BWA-207-C	3077818	Internal antenna 7 dBi, RP-SMA male	 <p>Technical drawing of the BWA-207-C antenna. It shows a vertical antenna with a total height of 166 mm. The bottom section has a diameter of 13 mm. The antenna is shown at a 90-degree angle to the mounting surface.</p>