

WL50SGL5Q

Work Light – Spotlight

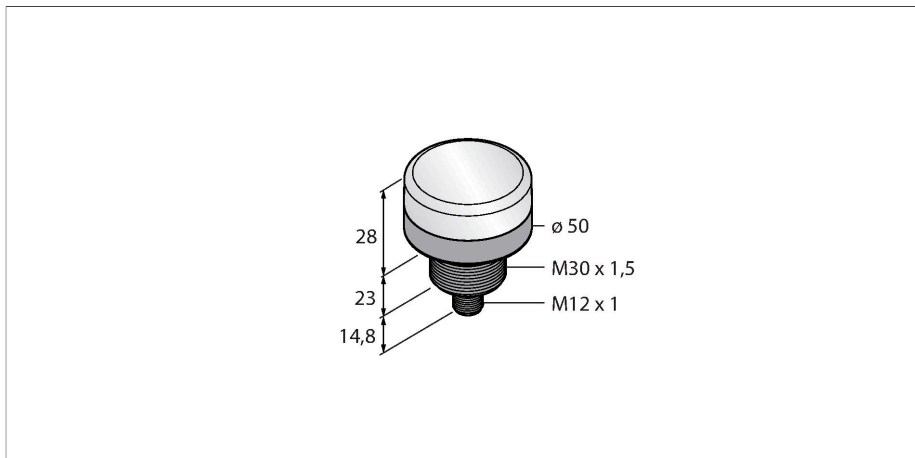

Technical data

Type	WL50SGL5Q
ID	3018742
Signal and display data	
Purpose	LED work light
Function	Spotlight
Light type	Green
Luminous flux lumen	210 lm
Aperture angle degree	5°
Beam angle	5°
LED service life (L70)	50000 h
Dimmable	No
Features of color 1	Green, Permanently on, 210 lm
Special features	Wash down
Electrical data	
Operating voltage	12...30 VDC
DC rated operational current	≤ 400 mA
Input power	1.7 W
Mechanical data	
Cascadable	No
Design	Puck, WL50S
Dimensions	Ø 50 x 65.8 mm
Housing material	Metal, AL, Black
Window material	Polycarbonate, clear
Electrical connection	Connector, M12 × 1, PVC
Number of cores	5
Ambient temperature	-20...+50 °C
Storage temperature	-40...+70 °C

Features

- Operating voltage: 12...30 VDC
- Protection class: IP69K
- Metal housing
- Color green
- M12 x 1 connector

Wiring diagram

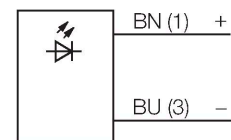

Functional principle

The energy-efficient LED work lights are ideally suited for industrial applications. The rugged IP69K protected versions can be used in many demanding applications where bright and uniform illumination is required. The electrical connection is either established via standard M12x1 connector or pigtail directly at the clamp connection of existing installations. On some models the light output is continuously dimmable via a PWM signal on pin 4.

Technical data

Relative humidity	0...95 %
Protection class	IP67 IP69
Tests/approvals	
Approvals	CE

Accessories

Dimension drawing	Type	ID	
	RKC4.4T-2/TEL	6625013	Connection cable, M12 female connector, straight, 4-pin, cable length: 2 m, jacket material: PVC, black; cULus approval
	WKC4.4T-2/TEL	6625025	Connection cable, M12 female connector, angled, 4-pin, cable length: 2 m, jacket material: PVC, black; cULus approval