

DF-G1-PS-Q7

Photoelectric Sensor – Photoelectric Sensor for Plastic Fibers

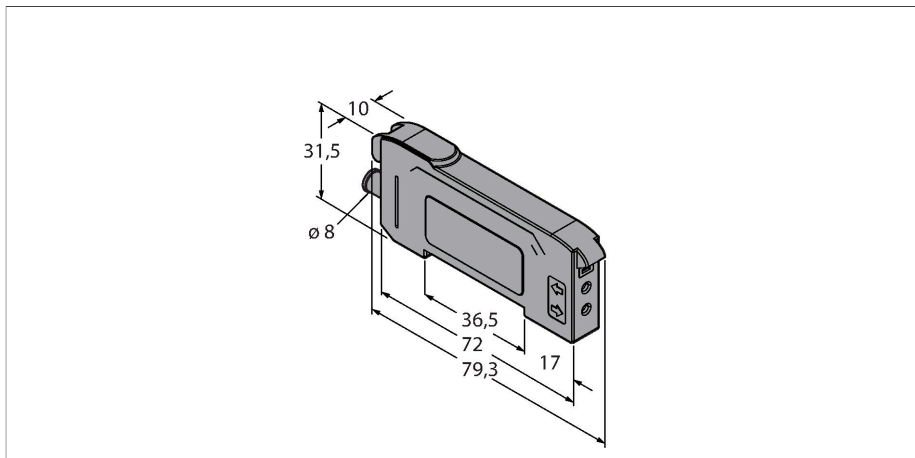

Technical data

Type	DF-G1-PS-Q7
ID	3019359
Optical data	
Function	Fiber optic sensor
Operating mode	Plastic fiber
Light type	Red
Wavelength	660 nm
Electrical data	
Operating voltage	10...30 VDC
Residual ripple	< 10 % U _{ss}
DC rated operational current	≤ 40 mA
Short-circuit protection	yes
Reverse polarity protection	yes
Output function	NO/NC, PNP
Switching frequency	5 kHz
Readiness delay	≤ 500 ms
Response time typical	< 0.2 ms
Setting option	Push Button Remote Teach
Mechanical data	
Design	Rectangular, DF-G1
Dimensions	79.3 x 10 x 33 mm
Housing material	Plastic, Thermoplastic material, Black
Electrical connection	Connector, M8 × 1, PVC
Number of cores	4
Ambient temperature	-10...+55 °C
Relative humidity	0...90 %

Features

- 8 mm connector, 4-pin
- Visible red light
- Programming via teach cable or multi-function button
- Operating voltage: 10...30 VDC
- PNP output
- Light/dark operation

Wiring diagram

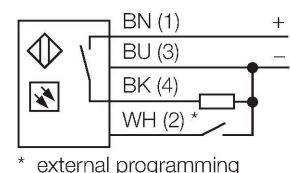

Functional principle

Glass or fiber optics are the optimum choice for high temperature or space restricted applications. Fiber optics transfer the light from the sensor to a remote object. Individual fiber optics are used for opposed mode sensing, whereas bifurcated fiber optics are suited for diffuse mode operation.

Technical data

Protection class	IP50
Special features	keep/defer
Switching state	LED, Yellow
Excess gain indication	Dual Digital Displays
Tests/approvals	
Approvals	CE, cULus listed

Excess Gain Curve

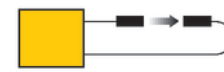

PIT16U	58 mm
PIT26U	220 mm
PIT46U	820 mm
PIT66U	1320 mm

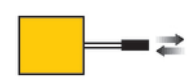



PBT16U	12 mm
PBT26U	80 mm
PBT46U	220 mm
PBT66U	310 mm

Accessories

DIN-35-70	3026604	DIN-35-105	3030470
	DIN rail, width 35 mm, length 70 mm		DIN rail, width 35 mm, length 105 mm
DIN-35-140	3026605		
	DIN rail, width 35 mm, length 140 mm		

Accessories

Dimension drawing	Type	ID	
	PKG4S-2/TEL	6627370	Connection cable, female Ø M8, straight, 4-pin, snap-on type, cable length: 2 m, jacket material: PVC, black; cULus approval; other cable lengths and qualities available, see www.turck.com
	PKW4S-2/TEL	6627373	Connection cable, Ø 8 mm female, snap-on type, angled, 4-pin, cable length: 2 m, jacket material: PVC, black; cULus approval; other cable lengths and qualities available, see www.turck.com

Accessories

Dimension drawing	Type	ID	
	PBT16U	3042822	Plastic fiber-optic sensor, operating mode: Diffuse mode, threaded sleeve M3 x 0.75 mm, field wireable wire without end tip, polyethylene sheath, ambient temperatures -30 °C...+70 °C

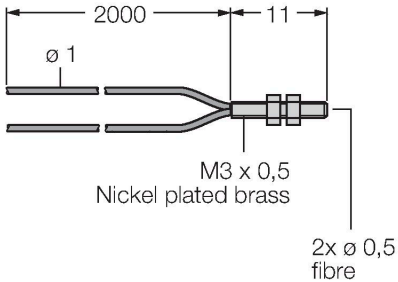
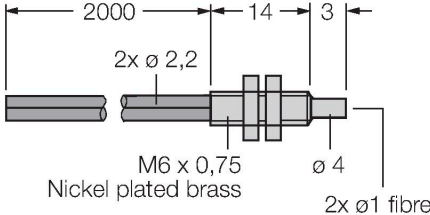
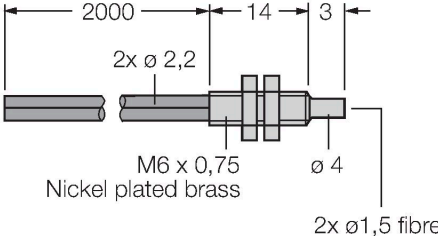
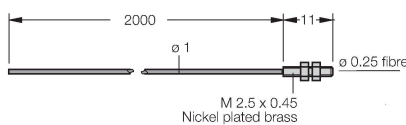
Dimension drawing	Type	ID	
 <p>Dimension drawing of PBT26U sensor. It shows a long cable with a diameter of $\varnothing 1$ mm. The total length is 2000 mm. The sensing tip is 11 mm long and features a threaded bush with an M3 x 0,5 thread. The tip is made of nickel-plated brass and contains two $\varnothing 0,5$ mm fibers.</p>	PBT26U	3026080	Plastic fiber, sensing mode: Diffuse mode, threaded bush M3 x 0.75 mm, preassembled wire without end tip, polyethylene jacket, ambient temperatures -30 °C...+70 °C
 <p>Dimension drawing of PBT46U sensor. It shows a long cable with a diameter of $\varnothing 2,2$ mm. The total length is 2000 mm. The sensing tip is 14 mm long and features a threaded sleeve with an M6 x 0,75 thread. The tip is made of nickel-plated brass and contains two $\varnothing 1$ mm fibers. The diameter of the tip is $\varnothing 4$ mm.</p>	PBT46U	3025967	Plastic fiber-optic sensor, operating mode: Diffuse mode, threaded sleeve M3 x 0.75 mm, field wireable wire without end tip, polyethylene sheath, ambient temperatures -30 °C...+70 °C
 <p>Dimension drawing of PBT66U sensor. It shows a long cable with a diameter of $\varnothing 2,2$ mm. The total length is 2000 mm. The sensing tip is 14 mm long and features a threaded sleeve with an M6 x 0,75 thread. The tip is made of nickel-plated brass and contains two $\varnothing 1,5$ mm fibers. The diameter of the tip is $\varnothing 4$ mm.</p>	PBT66U	3039982	Plastic fiber-optic sensor, operating mode: Diffuse mode, threaded sleeve M6 x 0.75 mm, pre-assembled wire without end tip, polyethylene sheath, ambient temperatures -30 °C...+70 °C
 <p>Dimension drawing of PIT16U sensor. It shows a long cable with a diameter of $\varnothing 1$ mm. The total length is 2000 mm. The sensing tip is 11 mm long and features a threaded sleeve with an M 2.5 x 0.45 thread. The tip is made of nickel-plated brass and contains one $\varnothing 0,25$ mm fiber.</p>	PIT16U	3039983	Plastic fiber-optic sensor, operating mode: Opposed mode, threaded sleeve M3 x 0.5 mm, field wireable wire without end tip, polyethylene sheath, ambient temperatures -30 °C...+70 °C

Dimension drawing	Type	ID	
	PIT26U	3026079	Plastic fiber, sensing mode: Opposed mode, threaded bush M3 x 0.5 mm, preassembled wire without end tip, polyethylene jacket, ambient temperatures -30 °C...+70 °C

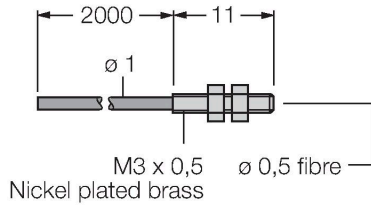

	PIT46U	3026034	Plastic fiber-optic sensor, operating mode: Opposed mode, threaded sleeve M3 x 0.5 mm, field wireable wire without end tip, polyethylene sheath, ambient temperatures -30 °C...+70 °C
--	--------	---------	---------------------------------------------------------------------------------------------------------------------------------------------------------------------------------------

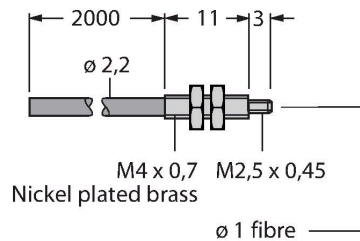

	PIT66U	3039899	Plastic fiber-optic sensor, operating mode: Opposed mode, threaded sleeve M3 x 0.5 mm, field wireable wire without end tip, polyethylene sheath, ambient temperatures -30 °C...+70 °C
--	--------	---------	---------------------------------------------------------------------------------------------------------------------------------------------------------------------------------------

