

Measuring Light Screen Receiver BMRL2432A

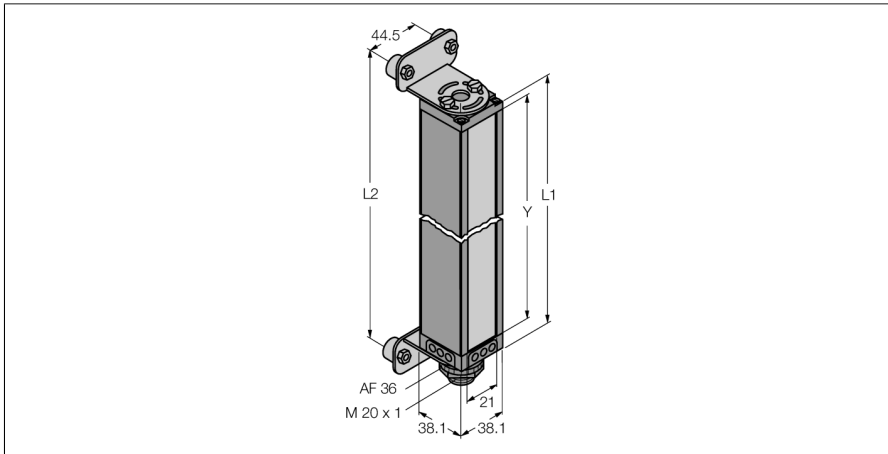

Type	BMRL2432A
ID	3038532
Optical data	
Function	Opposed mode sensor (receiver)
Operating mode	Receiver
Optical resolution	9.7 mm
Range	600...6100 mm
Scan field	600 mm
Number of beams	64
Electrical data	
Operating voltage U_s	11.4...14 VDC
Mechanical data	
Design	Rectangular, Mini Array
Housing material	Metal, AL
Lens	plastic, Acrylic
Electrical connection	Connector, 7/8"
Ambient temperature	-20...+70 °C
Protection class	IP65
Tests/approvals	
Approvals	CE
Approvals	CE
	cULus recognized

- Minimum target size 9.7 mm
- Scan field 591 mm
- Max. sensing range 6.1 m
- Operating voltage 11.8...12.2 VDC (from controller)
- Protection class IP65
- Adjustment via software

Functional principle

Measuring light screens are ideally suited for precise detection and inspection tasks such as product profiling, sizing, edge and centre guiding, hole and parts detection and the like. Each system consists of an emitter, receiver and a controller module, which is equipped with several switching and analogue outputs, depending on the specific version. The device also enables data transmission via RS232 or R485, either in a binary or ASCII code format. The scan times depend on the height of the measuring array and the adjusted scan mode. Detailed information can be taken from the instruction manual.