

QM42VN6LPQ

Photoelectric Sensor – Retroreflective Sensor with Polarizing Filter

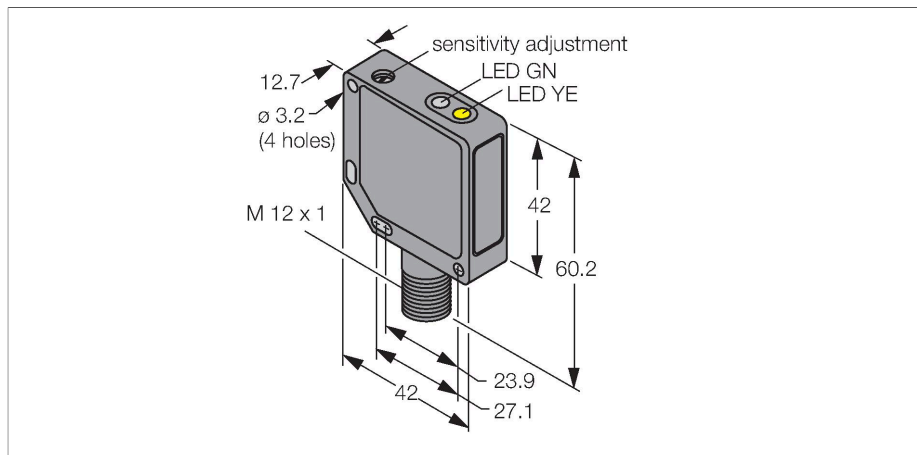

Features

- Male M12 × 1, 4-pin
- Metal housing, ZN, black
- Protection class IP67
- Sensitivity adjusted via potentiometer
- Operating voltage 10...30 VDC
- NPN switching output
- Light/dark operation

Wiring diagram

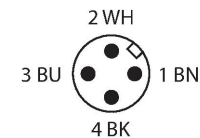
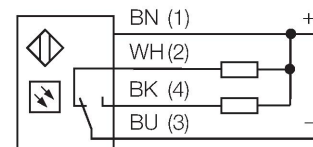

Technical data

Type	QM42VN6LPQ
ID	3044904
Optical data	
Function	Retroreflective Sensor
Operating mode	Polarized
Reflector included in delivery	no
Light type	Red polarized
Wavelength	660 nm
Range	150...3000 mm
Electrical data	
Operating voltage	10...30 VDC
Residual ripple	< 10 % U _{ss}
DC rated operational current	≤ 100 mA
No-load current	≤ 30 mA
Short-circuit protection	yes
Reverse polarity protection	yes
Output function	NO/NC, NPN
Switching frequency	≤ 500 Hz
Readiness delay	≤ 100 ms
Response time typical	< 1 ms
Overcurrent release	> 150 mA
Setting option	Potentiometer
Mechanical data	
Design	Rectangular, QM42
Dimensions	42 x 12.7 x 60.2 mm
Housing material	Metal, Zinc Alloy Die-Cast, Black-finished

Functional principle

Retro-reflective sensors incorporate emitter and receiver in a single compact housing. The light beam of the emitter is directed towards a reflector which returns the light back to the receiver. An object is detected when it interrupts this beam. Retro-reflective sensors incorporate some of the advantages of opposed mode sensors (good contrast and high excess gain). Further it is merely required to install and wire a single device. A smaller sensing range and susceptibility of devices without polarisation filter can be of disadvantage when shiny objects have to be detected.

Excess gain curve
Excess gain in relation to the distance

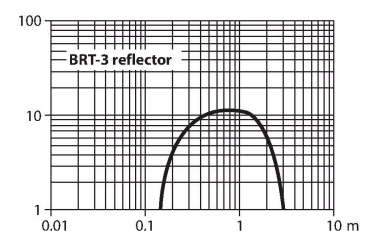

Technical data

Lens	plastic, Acrylic
Electrical connection	Connector, M12 × 1, PVC
Number of cores	4
Ambient temperature	-20...+70 °C
Protection class	IP67
Power-on indication	LED, Green
Switching state	LED, Yellow
Error indication	LED, green, Flashing
Excess gain indication	LED
Alarm display	LED yellow Flashing
Tests/approvals	
Approvals	CE, cURus

Accessories

SMB30SK

3052523

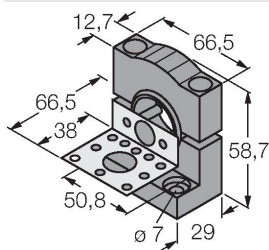

Mounting bracket, PBT black, with mounting plate, stainless steel, for types with 18 mm thread, QM42/QMT42

SMB46S

3048748

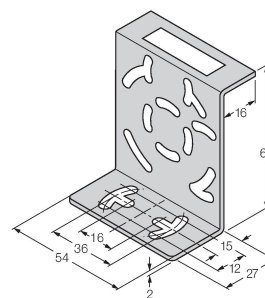

Mounting bracket, stainless steel, for QS18, QS30, MINI-BEAM, QM42/QMT42

SMB46L

3048747

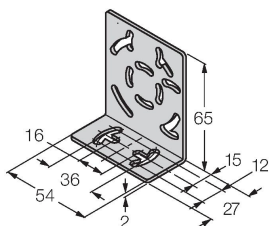

Mounting bracket, stainless steel, for QS18, QS30, MINI-BEAM, QM42/QMT42

Accessories

Dimension drawing	Type	ID	
	RKC4.4T-2/TEL	6625013	Connection cable, female M12, straight, 4-pin, cable length: 2 m, sheath material: PVC, black; cULus approval; other cable lengths and qualities available, see www.turck.com

Dimension drawing	Type	ID	
	WKC4.4T-2/TEL	6625025	Connection cable, female M12, angled, 4-pin, cable length: 2 m, sheath material: PVC, black; cULus approval; other cable lengths and qualities available, see www.turck.com

Accessories

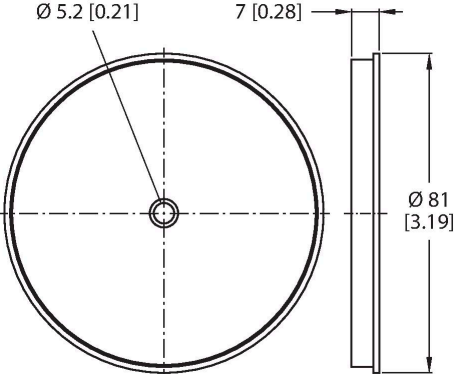
Dimension drawing	Type	ID	
	BRT-3	3016164	Round reflector, reflection coefficient 1.0, material acrylic, ambient temperature -20...+60 °C