

Q45UBB63BCQ6

Ultrasonic Sensor – diffuse mode sensor

With Switching Output

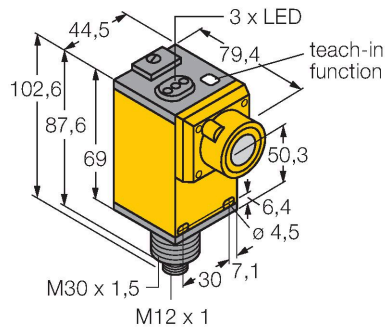

Features

- Start and End of switching range adjustable via teach button
- NO/NC output function
- Response time, adjustable
- Pump function
- PNP transistor output (NO)
- Aperture angle of sonic cone 12 °
- Blind zone: 25 cm
- Range: 300 cm

Wiring diagram

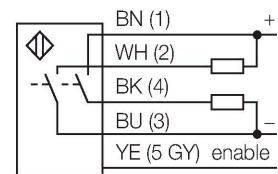

Functional principle

Ultrasonic sensors detect a multitude of objects contactless and wear-free with ultrasonic waves. Regardless of whether the object is transparent or opaque, metallic or non-metallic, liquid, solid or powdery. Even environmental conditions such as spray, dust or rain hardly affect their function.

Technical data

Type	Q45UBB63BCQ6
ID	3046363
Ultrasonic data	
Function	Proximity switch
Range	250...3000 mm
Ultrasound frequency	128 kHz
Repeatability	≤ ± 0.5 mm
Temperature drift	≤ 0.13 % of full scale/K
Electrical data	
Operating voltage	12...24 VDC
Response time typical	< 40 ms
Output function	NO contact, PNP/NPN
Switching frequency	≤ 50 Hz
Hysteresis	≤ 1 mm
Short-circuit protection	yes / Cyclic
Reverse polarity protection	Complete
Mechanical data	
Design	Rectangular, Q45
Radiation direction	straight
Dimensions	79.4 x 44.5 x 102.6 mm
Housing material	Plastic, PBT
Transducer material	Plastic, Epoxyd resin and PU foam
Electrical connection	Connector, M12 × 1, PVC
Ambient temperature	-25...+70 °C
Relative humidity	100 %

Technical data

Protection class	IP67
Tests/approvals	
MTTF	50 years acc. to SN 29500 (Ed. 99) 40 °C
Approvals	CE

Accessories

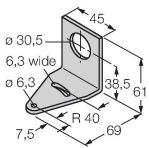
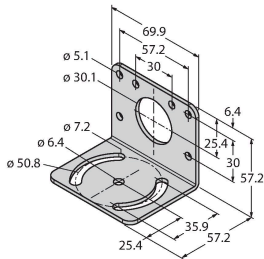
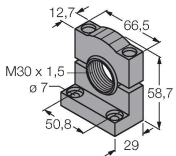
SMB30A	3032723	SMB30MM	3027162
 <p>Mounting bracket, rectangular, stainless steel, for sensors with 30mm thread</p>		 <p>Mounting bracket, rectangular, stainless steel, for sensors with 30 mm thread, wide holes for accurate alignment</p>	
SMB30SC	3052521		
 <p>Mounting bracket, PBT black, for sensors with 30 mm thread, rotatable</p>			

Accessories

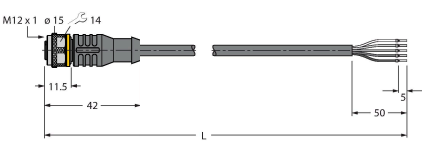
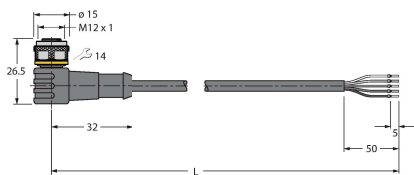
Dimension drawing	Type	ID	
	RKC4.5T-2/TEL	6625016	Connection cable, M12 female connector, straight, 5-pin, cable length: 2 m, jacket material: PVC, black; cULus approval
	WKC4.5T-2/TEL	6625028	Connection cable, M12 female connector, angled, 5-pin, cable length: 2 m, jacket material: PVC, black; cULus approval