

# Q45VR3FPQ

## Photoelectric Sensor – Photoelectric Sensor for Plastic Fibers

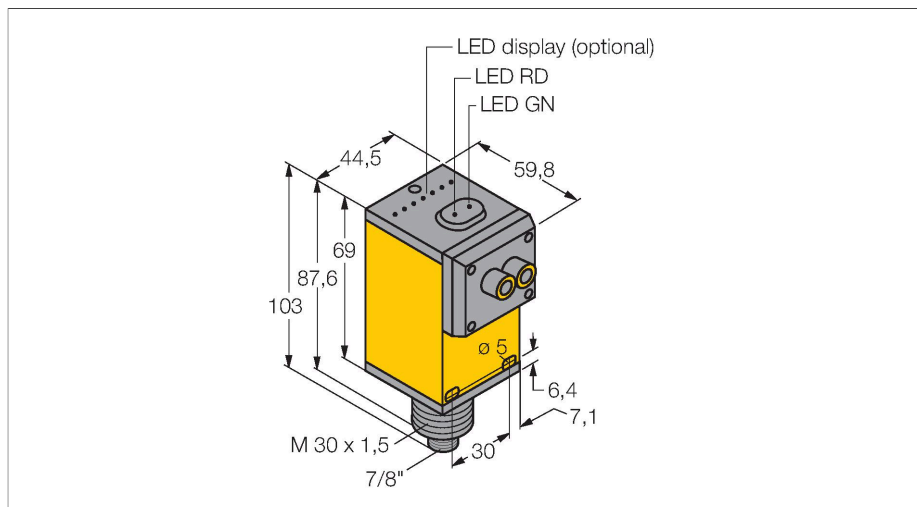

### Features

- Male connector 7/8"
- Protection class IP67
- Sensitivity adjusted via potentiometer
- Adapter set PFK-B for connecting plastic optical fibers are available separately
- Operating voltage: 12...250 VDC or 24...250 VAC
- Relay output, changeover (SPDT)
- Light or dark operation, adjusted via selector switch

### Wiring diagram

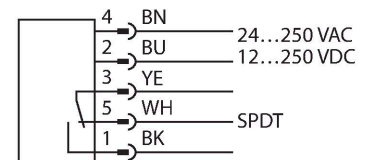

### Technical data

Type	Q45VR3FPQ
ID	3054312
<b>Optical data</b>	
Function	Fiber optic sensor
Operating mode	Plastic fiber
Fiber-optic type	plastic
Light type	Red
Wavelength	660 nm
<b>Electrical data</b>	
Operating voltage	12...250 VDC
Operating voltage	24...250 VAC
Output function	Complementary contact, Relay output
Switching frequency	≤ 33 Hz
Readiness delay	≤ 100 ms
Response time typical	< 15 ms
Setting option	Potentiometer
<b>Mechanical data</b>	
Design	Rectangular, Q45
Dimensions	60.5 x 44.5 x 101.6 mm
Housing material	Plastic, Thermoplastic material
Lens	plastic, Acrylic
Electrical connection	Connector, 7/8", PVC
Number of cores	5
Ambient temperature	-25...+55 °C
Relative humidity	0...90 %
Protection class	IP67

### Functional principle

Glass or fibre optic sensors are the optimum choice for high temperature or space restricted applications. Fibre optics transfer the light from the sensor to a remote object. Individual fibre optics are used for opposed mode sensing, whereas bifurcated fibre optics are suited for retro-reflective or diffuse mode operation.  
 Excess gain curve  
 Excess gain in relation to the distance

## Technical data

Special features	keep/defer Wash down
Power-on indication	LED, Green
Switching state	LED, Yellow
Error indication	LED, green
Excess gain indication	LED, red
<b>Tests/approvals</b>	
MTTF	67 years acc. to SN 29500 (Ed. 99) 40 °C
Approvals	CE, cURus, CSA

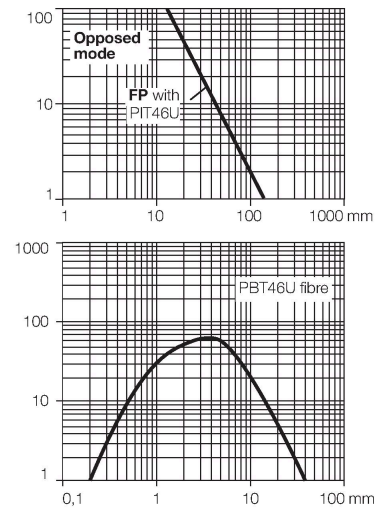

## Accessories

SMB30A

3032723

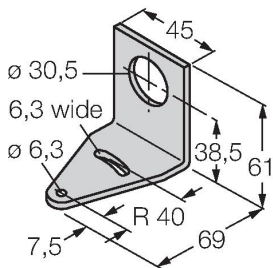

Mounting bracket, rectangular, stainless steel, for sensors with 30mm thread

SMB30FAM10

3011185

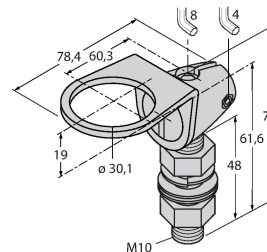

Mounting bracket, stainless steel, for M10 x 1.5 thread, thread length 30 mm

SMB30SC

3052521

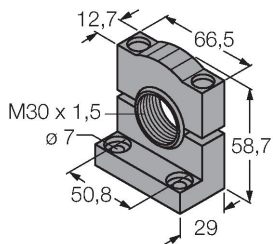

Mounting bracket, PBT black, for sensors with 30 mm thread, rotatable

PFK-B

3093520

Adapter set with 4 adapters per set to connect plastic optical fibers to Q45 fiber-optic sensors

Accessories

Dimension drawing	Type	ID	
	PBT46U	3025967	Plastic fiber-optic sensor, operating mode: Diffuse mode, threaded sleeve M3 x 0.75 mm, field wireable wire without end tip, polyethylene sheath, ambient temperatures -30 °C...+70 °C

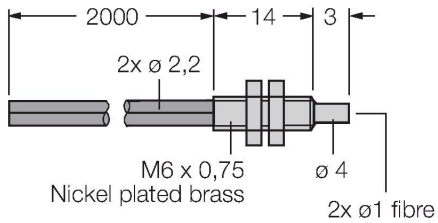

PIT46U

3026034

Plastic fiber-optic sensor, operating mode: Opposed mode, threaded sleeve M3 x 0.5 mm, field wireable wire without end tip, polyethylene sheath, ambient temperatures -30 °C...+70 °C

