

Q45VR3FVQ

Photoelectric Sensor – Photoelectric Sensor for Glass Fibers

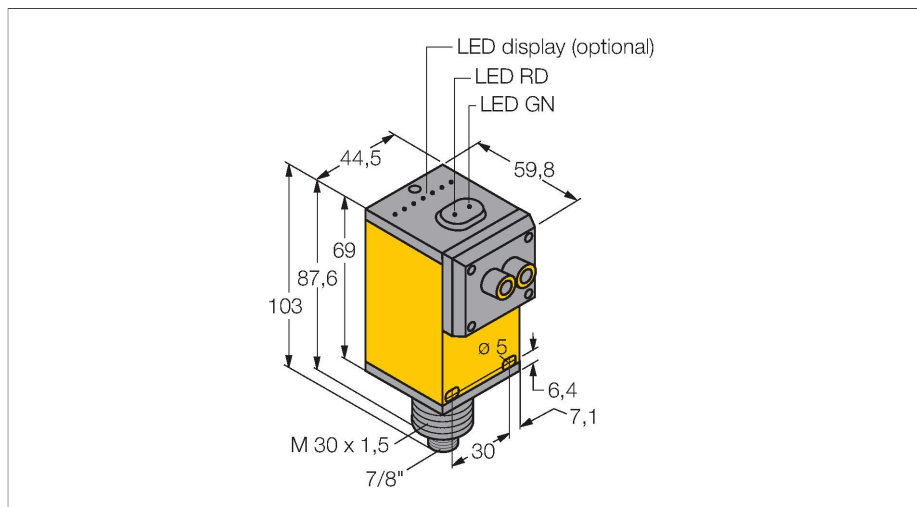

Features

- Male connector 7/8"
- Protection class IP67
- Sensitivity adjusted via potentiometer
- Operating voltage: 12...250 VDC or 24...250 VAC
- Relay output, changeover (SPDT)
- Light or dark operation, adjusted via selector switch

Wiring diagram

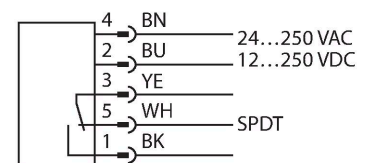

Technical data

Type	Q45VR3FVQ
ID	3054313
Optical data	
Function	Fiber optic sensor
Operating mode	Glass fiber
Fiber-optic type	glass
Light type	IR
Wavelength	880 nm
Electrical data	
Operating voltage	12...250 VDC
Operating voltage	24...250 VAC
Output function	Complementary contact, Relay output
Switching frequency	≤ 33 Hz
Readiness delay	≤ 100 ms
Response time typical	< 15 ms
Setting option	Potentiometer
Mechanical data	
Design	Rectangular, Q45
Dimensions	60.5 x 44.5 x 101.6 mm
Housing material	Plastic, Thermoplastic material
Lens	plastic, Acrylic
Electrical connection	Connector, 7/8", PVC
Number of cores	5
Ambient temperature	-25...+55 °C
Relative humidity	0...90 %
Protection class	IP67

Functional principle

Glass or fibre optic sensors are the optimum choice for high temperature or space restricted applications. Fibre optics transfer the light from the sensor to a remote object. Individual fibre optics are used for opposed mode sensing, whereas bifurcated fibre optics are suited for retro-reflective or diffuse mode operation.
 Excess gain curve
 Excess gain in relation to the distance

Technical data

Special features	keep/defer Wash down
Power-on indication	LED, Green
Switching state	LED, Yellow
Error indication	LED, green
Excess gain indication	LED, red
Tests/approvals	
MTTF	67 years acc. to SN 29500 (Ed. 99) 40 °C
Approvals	CE, cURus, CSA

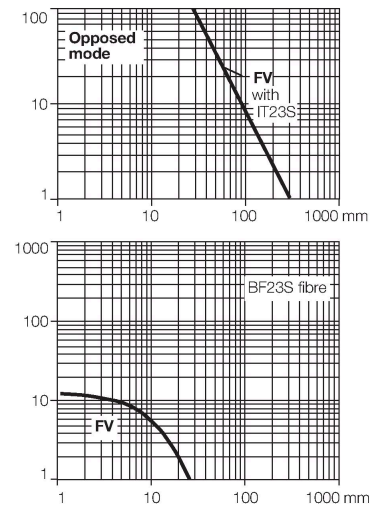

Accessories

SMB30A

3032723

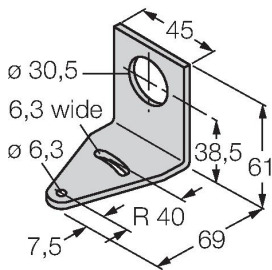

Mounting bracket, rectangular, stainless steel, for sensors with 30mm thread

SMB30FAM10

3011185

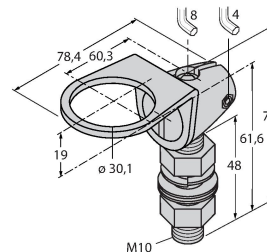

Mounting bracket, stainless steel, for M10 x 1.5 thread, thread length 30 mm

SMB30SC

3052521

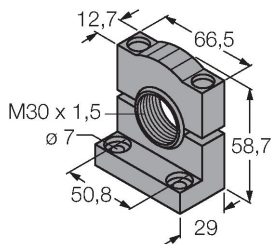

Mounting bracket, PBT black, for sensors with 30 mm thread, rotatable

Accessories

Dimension drawing	Type	ID	
	IT23S	3017355	Glass fiber, sensing mode: Opposed mode, threaded sleeve (brass), bundle diameter 3.2 mm, flexible stainless steel jacket, ambient temperatures -140... +250 °C

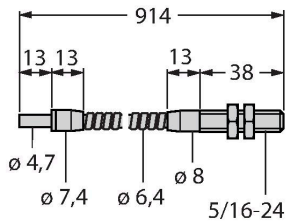

BT23S

3017276

Glass fiber, sensing mode: Diffuse mode, threaded sleeve (brass), bundle diameter 3.2 mm, flexible stainless steel jacket, ambient temperatures -140... +250 °C

