

QS186E W/30'

Photoelectric Sensor – Opposed Mode Sensor (Emitter)

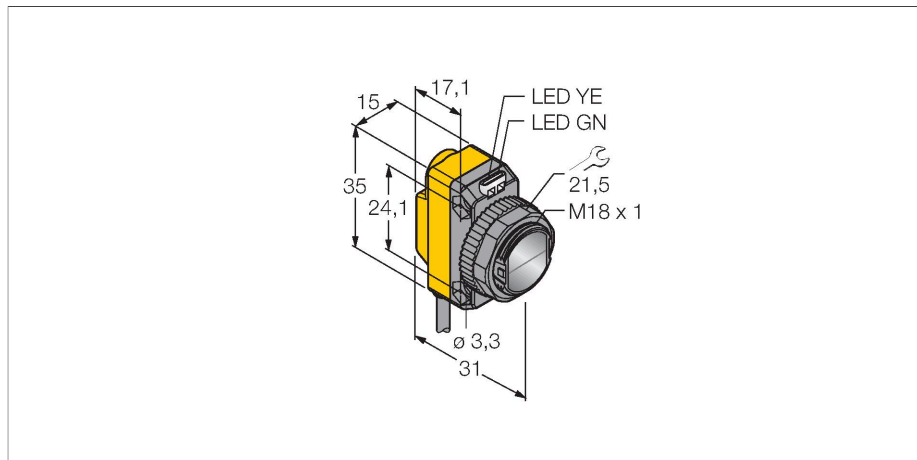

Technical data

| | |
|------------------------------|-------------------------------|
| Type | QS186E W/30' |
| ID | 3061620 |
| Optical data | |
| Function | Opposed mode sensor |
| Operating mode | Emitter |
| Light type | IR |
| Wavelength | 940 nm |
| Range | 0...20000 mm |
| Electrical data | |
| Operating voltage | 10...30 VDC |
| Residual ripple | < 10 % U _{ss} |
| DC rated operational current | ≤ 100 mA |
| Short-circuit protection | yes |
| Reverse polarity protection | yes |
| Readiness delay | ≤ 100 ms |
| Mechanical data | |
| Design | Rectangular with thread, QS18 |
| Dimensions | Ø 18 x 31 x 15 x 35 mm |
| Housing material | Plastic, ABS |
| Lens | plastic, Acrylic |
| Electrical connection | Cable, 9 m, PVC |
| Number of cores | 2 |
| Core cross-section | 0.35 mm ² |
| Ambient temperature | -20...+70 °C |
| Protection class | IP67 |
| Power-on indication | LED, Green |
| Excess gain indication | LED |

Features

- Cable, PVC, 9 m
- Protection class IP67
- LED all-round visible
- Operating voltage: 10...30 VDC

Wiring diagram

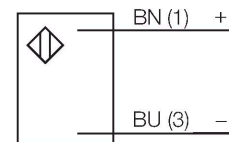

Functional principle

Opposed mode sensors consist of an emitter and receiver. They are installed opposite to each other so that the light from the emitter is aimed directly at the receiver. When an object interrupts or weakens the light beam, the sensor switches. Opposed mode sensors are the most reliable photoelectric sensors for detection of opaque targets. The excellent light/dark contrast and the high excess gain allow operation over larger distances and under difficult conditions.

Excess gain curve
Excess gain in relation to the distance (type 6EB/RB)

Technical data

Tests/approvals

MTTF 530 years acc. to SN 29500 (Ed. 99) 40 °C

Approvals CE, cURus

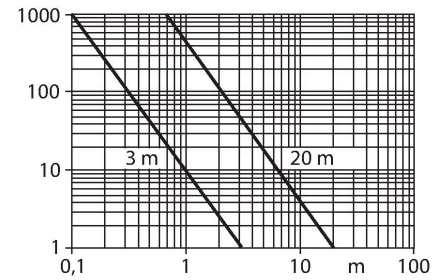

Accessories

SMB18A

3033200

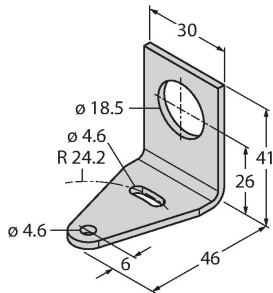

Mounting bracket, rectangular, stainless steel, for sensors with 18 mm thread

SMB18AFAM10

3012558

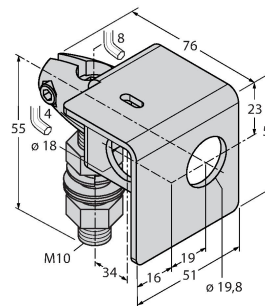

Mounting bracket, material VA 1.4401, for M10 x 1.5 thread, thread length 18 mm

SMBQS18A

3069721

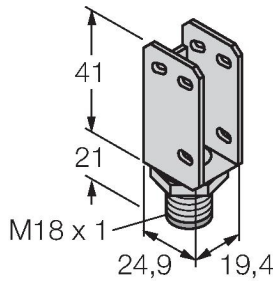

Mounting bracket, stainless steel, for 18 mm thread

SMB18SF

3052519

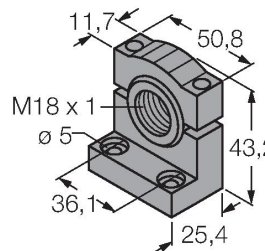

Mounting bracket, PBT black, for sensors with 18 mm thread, rotatable