

# QS18VP6LP W/30

## Photoelectric Sensor – Retroreflective Sensor with Polarizing Filter

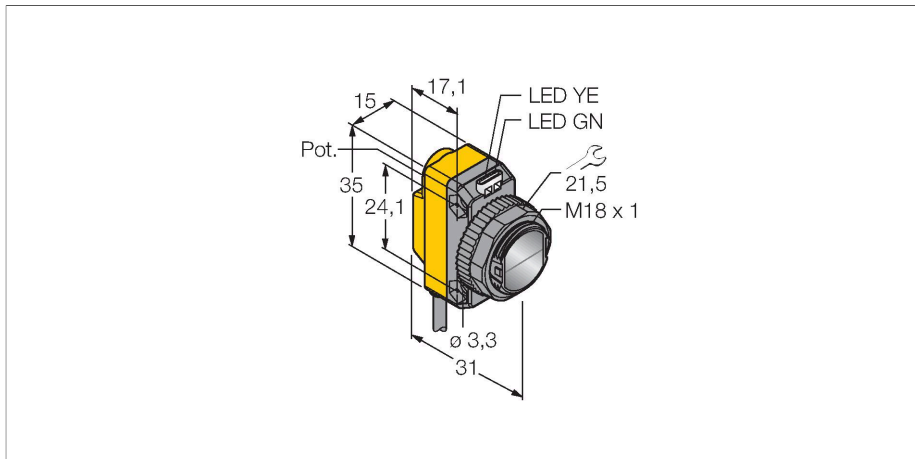

### Technical data

|                                |                               |
|--------------------------------|-------------------------------|
| Type                           | QS18VP6LP W/30                |
| ID                             | 3061632                       |
| <b>Optical data</b>            |                               |
| Function                       | Retroreflective Sensor        |
| Operating mode                 | Polarized                     |
| Reflector included in delivery | no                            |
| Light type                     | Red polarized                 |
| Wavelength                     | 630 nm                        |
| Range                          | 50...3500 mm                  |
| <b>Electrical data</b>         |                               |
| Operating voltage              | 10...30 VDC                   |
| Residual ripple                | < 10 % U <sub>ss</sub>        |
| DC rated operational current   | ≤ 100 mA                      |
| Short-circuit protection       | yes                           |
| Reverse polarity protection    | yes                           |
| Output function                | NO/NC, PNP                    |
| Current output                 | 100 mA                        |
| Switching frequency            | ≤ 800 Hz                      |
| Readiness delay                | ≤ 100 ms                      |
| Response time typical          | < 0.6 ms                      |
| Setting option                 | Potentiometer                 |
| <b>Mechanical data</b>         |                               |
| Design                         | Rectangular with thread, QS18 |
| Dimensions                     | Ø 18 x 31 x 15 x 35 mm        |
| Housing material               | Plastic, ABS                  |
| Lens                           | plastic, Acrylic              |

### Features

- Cable, PVC, 2 m
- Protection class IP67
- LED all-round visible
- Sensitivity adjusted via potentiometer
- Cable 9 m

### Wiring diagram

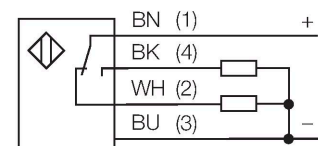

### Functional principle

Retroreflective sensors have emitter and receiver circuitry incorporated in the same housing. The light beam of the emitter is directed towards a reflector which returns the light back to the receiver. A target is detected when it interrupts this beam. Retroreflective sensors feature some of the advantages of opposed mode sensors, such as good contrast and high excess gain. Furthermore, only one device has to be installed and wired. Devices without polarizing filter have a smaller sensing range and are more susceptible to disturbances caused by shiny objects.

Excess gain curve  
Excess gain in relation to the distance (polarized)

## Technical data

|                        |                       |
|------------------------|-----------------------|
| Electrical connection  | Cable, 9 m, PVC       |
| Number of cores        | 4                     |
| Core cross-section     | 0.35 mm <sup>2</sup>  |
| Ambient temperature    | -20...+70 °C          |
| Protection class       | IP67                  |
| Power-on indication    | LED, Green            |
| Switching state        | LED, Yellow           |
| Error indication       | LED, green, Flashing  |
| Excess gain indication | LED, yellow, flashing |
| <b>Tests/approvals</b> |                       |
| Approvals              | CE, cURus             |

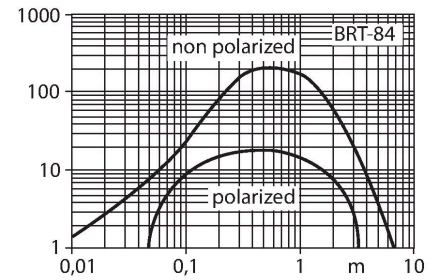

## Accessories

SMB18A

3033200

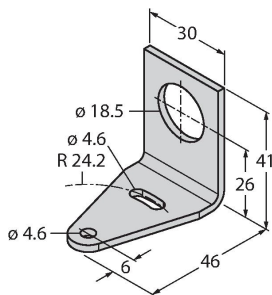

Mounting bracket, rectangular, stainless steel, for sensors with 18 mm thread

SMB18AFAM10

3012558

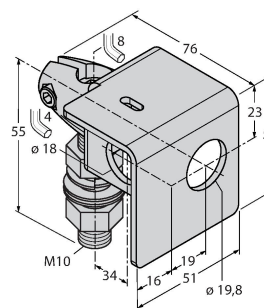

Mounting bracket, material VA 1.4401, for M10 x 1.5 thread, thread length 18 mm

SMBQS18A

3069721

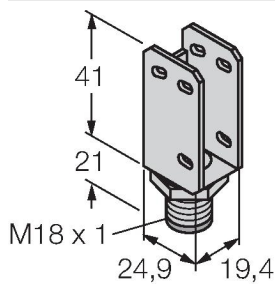

Mounting bracket, stainless steel, for 18 mm thread

SMB18SF

3052519

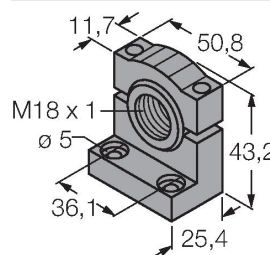

Mounting bracket, PBT black, for sensors with 18 mm thread, rotatable

## Accessories

| Dimension drawing | Type   | ID      |   |
|-------------------|--------|---------|---|
|                   | BRT-84 | 3058979 | Round reflector, reflection coefficient 1.4, material acrylic, ambient temperature -20 ... +60 °C |

