

QS18VP6CV45

Photoelectric Sensor – Convergent Mode Sensor

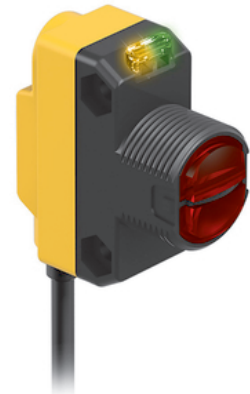
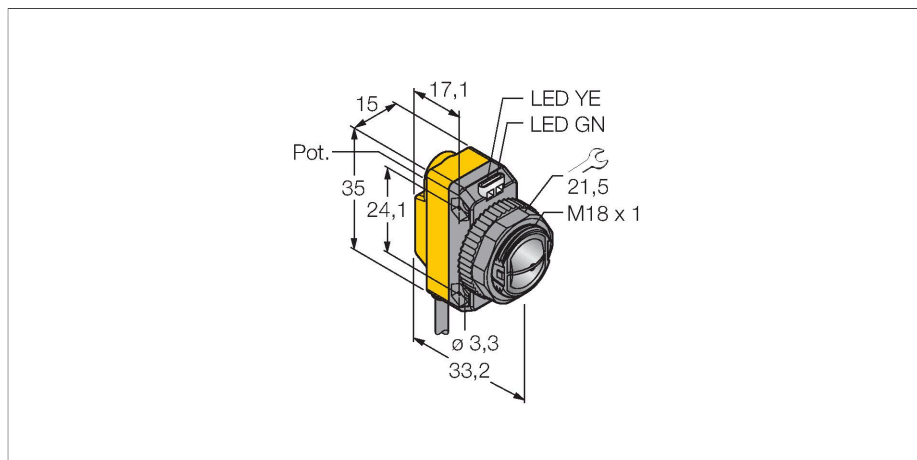

Technical data

Type	QS18VP6CV45
ID	3061648
Optical data	
Function	Proximity switch
Operating mode	Convergent
Light type	Red
Wavelength	630 nm
Focal distance	43 mm
Range	43 mm
Electrical data	
Operating voltage	10...30 VDC
Residual ripple	< 10 % U _{ss}
DC rated operational current	≤ 100 mA
Short-circuit protection	yes
Reverse polarity protection	yes
Output function	NO/NC, PNP
Current output	100 mA
Switching frequency	≤ 800 Hz
Readiness delay	≤ 100 ms
Response time typical	< 0.6 ms
Setting option	Potentiometer
Mechanical data	
Design	Rectangular with thread, QS18
Dimensions	Ø 18 x 33.2 x 15 x 35 mm
Housing material	Plastic, ABS
Lens	plastic, Acrylic
Electrical connection	Cable, 2 m, PVC

Features

- Cable, PVC, 2 m
- Protection class IP67
- LED all-round visible
- Sensitivity adjusted via potentiometer
- Operating voltage: 10...30 VDC
- PNP switching output, changeover

Wiring diagram

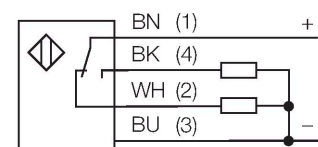

Functional principle

Convergent mode sensors are equipped with a lens in front of the emitter diode that produces a small and intense focal point at a defined distance from the sensor. Similar to diffuse mode sensors, the light reflected by the target is evaluated. Convergent mode sensors are ideal for detection of small targets or colour marks and edge guiding or positioning control of transparent materials. The targets must always be within the focal depth of the sensors. The focal depth is defined as the area in front of or behind the focal point within which the object can be detected. Based on the intense light concentration in the focal point, convergent mode sensors are capable of detecting targets with a low reflectivity.

Excess gain curve
Excess gain in relation to the distance

Technical data

Number of cores	4
Core cross-section	0.35 mm ²
Ambient temperature	-20...+70 °C
Protection class	IP67
Power-on indication	LED, Green
Switching state	LED, Yellow
Error indication	LED, green, Flashing
Excess gain indication	LED, yellow, flashing
Tests/approvals	
Approvals	CE, cURus

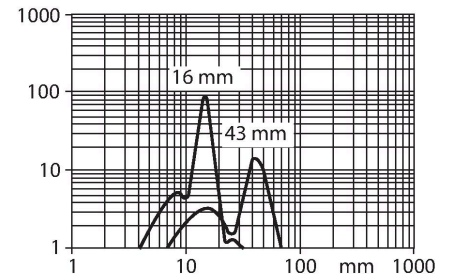

Accessories

SMB18A 3033200

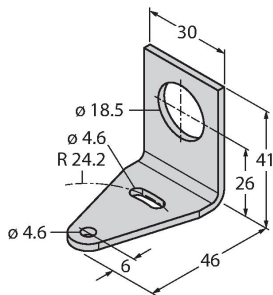

Mounting bracket, rectangular, stainless steel, for sensors with 18 mm thread

SMB18AFAM10 3012558

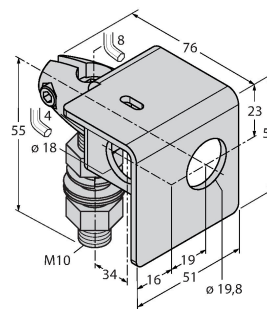

Mounting bracket, material VA 1.4401, for M10 x 1.5 thread, thread length 18 mm

SMBQS18A 3069721

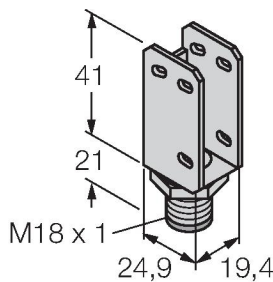

Mounting bracket, stainless steel, for 18 mm thread

SMB18SF 3052519

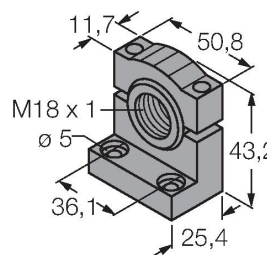

Mounting bracket, PBT black, for sensors with 18 mm thread, rotatable