

QS186EQ8

Photoelectric Sensor – Opposed Mode Sensor (Emitter)

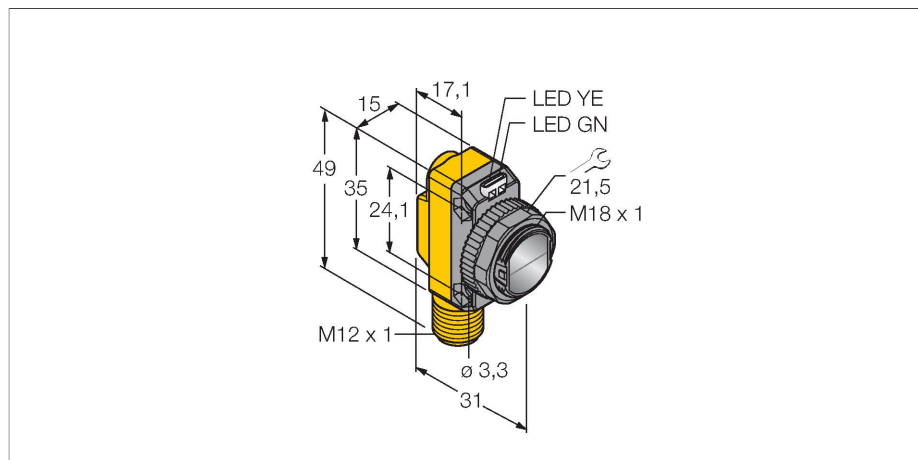

Technical data

Type	QS186EQ8
ID	3066447
Optical data	
Function	Opposed mode sensor
Operating mode	Emitter
Light type	IR
Wavelength	940 nm
Range	0...20000 mm
Electrical data	
Operating voltage	10...30 VDC
Residual ripple	< 10 % U _{ss}
DC rated operational current	≤ 100 mA
Short-circuit protection	yes
Reverse polarity protection	yes
Readiness delay	≤ 100 ms
Mechanical data	
Design	Rectangular with thread, QS18
Dimensions	Ø 18 x 31 x 15 x 35 mm
Housing material	Plastic, ABS
Lens	plastic, Acrylic
Electrical connection	Connector, M12 × 1, PVC
Number of cores	4
Ambient temperature	-20...+70 °C
Protection class	IP67
Power-on indication	LED, Green
Excess gain indication	LED

Features

- Male M12 × 1, 4-pin
- Protection class IP67
- LED all-round visible
- Operating voltage: 10...30 VDC

Wiring diagram

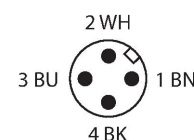
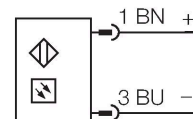

Functional principle

Opposed mode sensors consist of an emitter and receiver. They are installed opposite to each other so that the light from the emitter is aimed directly at the receiver. When an object interrupts or weakens the light beam, the sensor switches. Opposed mode sensors are the most reliable photoelectric sensors for detection of opaque targets. The excellent light/dark contrast and the high excess gain allow operation over larger distances and under difficult conditions.

Excess gain curve
Excess gain in relation to the distance (type 6EB/RB)

Technical data

Tests/approvals

MTTF 530 years acc. to SN 29500 (Ed. 99) 40 °C

Approvals CE, cURus

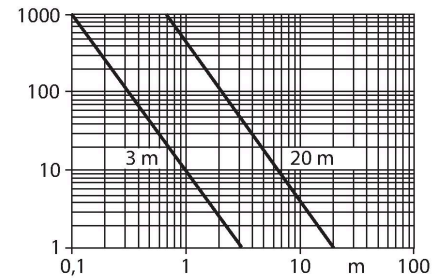

Accessories

SMB18A

3033200

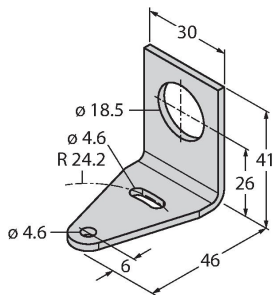

Mounting bracket, rectangular, stainless steel, for sensors with 18 mm thread

SMB18AFAM10

3012558

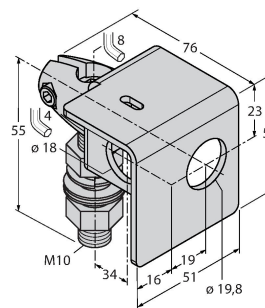

Mounting bracket, material VA 1.4401, for M10 x 1.5 thread, thread length 18 mm

SMBQS18A

3069721

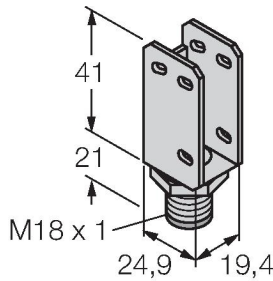

Mounting bracket, stainless steel, for 18 mm thread

SMB18SF

3052519

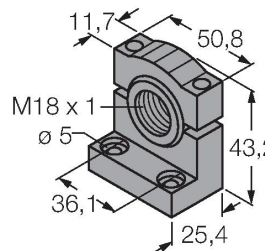

Mounting bracket, PBT black, for sensors with 18 mm thread, rotatable

Accessories

Dimension drawing

Type

ID

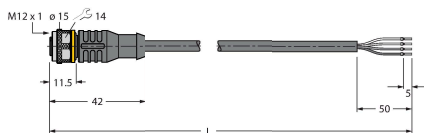

RKC4.4T-2/TEL

6625013

Connection cable, female M12, straight, 4-pin, cable length: 2 m, sheath material: PVC, black; cULus approval; other cable lengths and qualities available, see www.turck.com

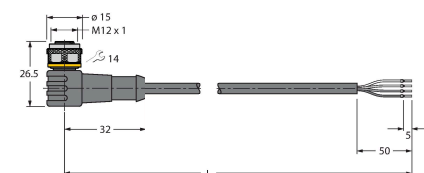

WKC4.4T-2/TEL

6625025

Connection cable, female M12, angled, 4-pin, cable length: 2 m, sheath material: PVC, black; cULus approval; other cable lengths and qualities available, see www.turck.com