

# LX24EQ

## Photoelectric Sensor – Opposed Mode Sensor (Emitter)

### Emitter

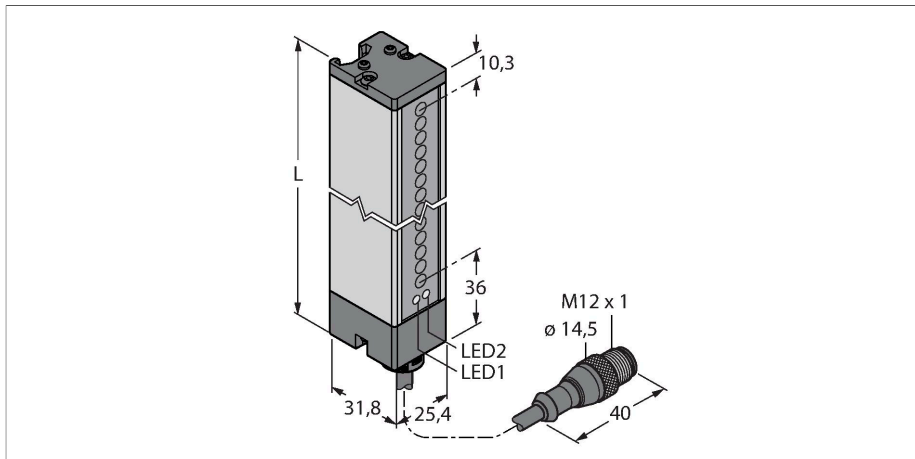

#### Technical data

Type	LX24EQ
ID	3071802
<b>Optical data</b>	
Function	Light screen
Operating mode	Emitter
Light type	IR
Wavelength	880 nm
Optical resolution	9.5 mm
Range	150...2000 mm
Scan field	599 mm
<b>Electrical data</b>	
Operating voltage	10...30 VDC
Residual ripple	< 10 % U <sub>ss</sub>
No-load current	≤ 100 mA
Short-circuit protection	yes
Reverse polarity protection	yes
Response time typical	< 6.4 ms
<b>Mechanical data</b>	
Design	Rectangular, LX
Dimensions	31.8 x 25.4 x 646.8 mm
Housing material	Metal, AL, Grey
Lens	plastic, Acrylic
Electrical connection	Cable with connector, M12 × 1, 0.15 m, PVC
Number of cores	5
Core cross-section	0.5 mm <sup>2</sup>

#### Features

- Cable with male end M12 × 1, 5-pin, 0.15 m
- Protection class IP65
- Scan field 599 mm
- Minimum target size 9.5 mm
- Operating voltage: 10 ... 30 VDC
- Programmable connection for reduced sensing range
- 2 slot nuts including M5 screws for wall mounting included in the scope of delivery

#### Wiring diagram

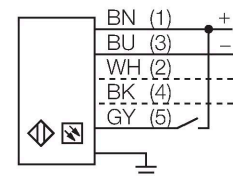

#### Functional principle

Light screens are used to monitor large areas. They consist of an emitter and a receiver. Switching light screens with scanning heights of up to 76 mm (LX3...) and up to 914 mm (Lx36...) are available. The crossed beams of the LX light screen enable small objects and/or objects that are not standard shapes to be reliably detected.

## Technical data

Ambient temperature	-20...+70 °C
Relative humidity	0...90 %
Protection class	IP65
Power-on indication	LED, Green
Error indication	LED, red, Flashing
<b>Tests/approvals</b>	
MTTF	74 years acc. to SN 29500 (Ed. 99) 40 °C
Approvals	CE, cURus



## Accessories

**SMBLX** 3002915

Mounting bracket, galvanized steel, for LX series, 2 pcs., not included in delivery

**SMBLXR** 3002914

Foot, galvanized steel, for LX series

## Accessories

Dimension drawing	Type	ID	
	MQDEC2-506	3060810	Anschlusskabel, PVC, geschirmt, Länge 1.83 m, M12 x 1 Kupplung 5-polig auf offenes Ende
	MQDEC2-506RA	3060813	Anschlusskabel, PVC, geschirmt, Länge 1.83 m, M12 x 1 Kupplung gewinkelt 5-polig auf offenes Ende
	RKC4.5T-2/TEL	6625016	Connection cable, female M12, straight, 5-pin, cable length: 2 m, sheath material: PVC, black; cULus approval; other cable lengths and qualities available, see <a href="http://www.turck.com">www.turck.com</a>
	WKC4.5T-2/TEL	6625028	Connection cable, female M12, angled, 5-pin, cable length: 2 m, sheath material: PVC, black; cULus approval; other cable lengths and qualities available, see <a href="http://www.turck.com">www.turck.com</a>