

QS18UNAEQ

Ultrasonic Sensor – diffuse mode sensor With Switching Output

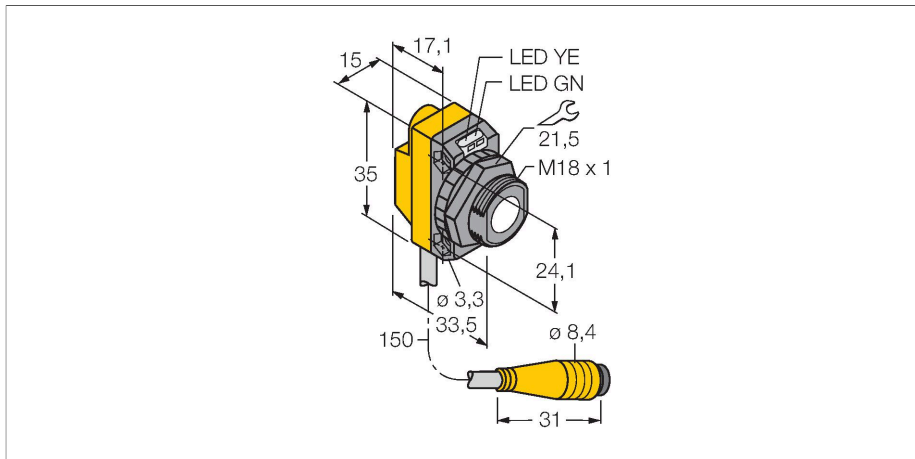

Features

- Operating voltage 12...30 VDC
- Compact design
- Pigtail with 8 mm male connector, snap-on type
- Switching range adjustable via teach-connection
- Adjustable to retroreflective mode
- Blind zone: 5 cm
- Range: 50 cm

Wiring diagram

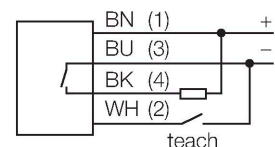

Functional principle

Ultrasonic sensors detect a multitude of objects contactless and wear-free with ultrasonic waves. Regardless of whether the object is transparent or opaque, metallic or non-metallic, liquid, solid or powdery. Even environmental conditions such as spray, dust or rain hardly affect their function.

Technical data

Type	QS18UNAEQ
ID	3073164
Ultrasonic data	
Function	Proximity switch
Range	50...500 mm
Ultrasound frequency	300 kHz
Repeatability	≤ ± 0.7 mm
Temperature drift	≤ 0.1 % of full scale/K
Edge lengths of the nominal actuator	50 mm
Electrical data	
Operating voltage	12...30 VDC
No-load current	≤ 25 mA
Response time typical	< 15 ms
Readiness delay	≤ 300 ms
Output function	NO contact, NPN
Switching frequency	≤ 33 Hz
Hysteresis	≤ 1.4 mm
Short-circuit protection	yes
Reverse polarity protection	Complete
Wire breakage protection	yes
Mechanical data	
Design	Rectangular with thread, QS18U
Radiation direction	straight
Dimensions	33.5 x 15 x 35 mm
Housing material	Plastic, ABS

Technical data

Transducer material	Plastic, Epoxyd resin and PU foam
Electrical connection	Cable with connector, M8 x 1, 0.15 m, PVC
Ambient temperature	-20...+60 °C
Storage temperature	-40...+85 °C
Relative humidity	100 %
Protection class	IP68
Power-on indication	LED, Green
Switching state	LED, Yellow
Object detected	LED, Green
Tests/approvals	
Approvals	CE

Accessories

SMB18A MONTAGEHILFE 3470200

Mounting bracket, stainless steel, for sensors with 18 mm thread

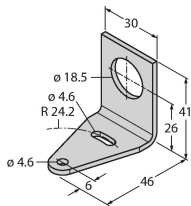

SMB18SF 3052519

Mounting bracket, PBT black, for sensors with 18 mm thread, rotatable

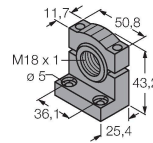

SMB18FA 3074004

Mounting bracket, material VA 1.4401, for 18 mm thread, 3/8" - 16 x 2" thread

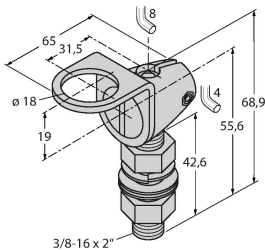

SMB18FM 3079421

mounting bracket, black, M22 x1.5 mm, male thread, female thread M18 x 1, for sensors with 18 mm thread

SMB18UR 3052517

Mounting bracket, for wall mounting, stainless steel 300, 2-piece, rotatable, 18 mm bore hole, screw set included

SMB18A 3033200

Mounting bracket, rectangular, stainless steel, for sensors with 18 mm thread

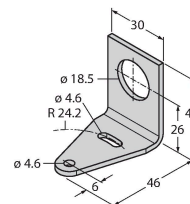

SMB18AFAM10

3012558

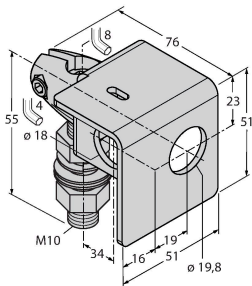

Mounting bracket, material VA 1.4401, for M10 x 1.5 thread, thread length 18 mm

Accessories

Dimension drawing	Type	ID	
-------------------	------	----	--

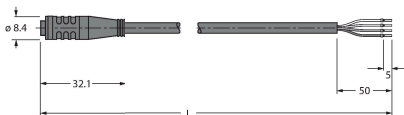

PKG4S-2/TEL

6627370

Connection cable, Ø 8-mm female connector, snap-on, straight, 4-pin, cable length: 2 m, jacket material: PVC, black; cULus approval

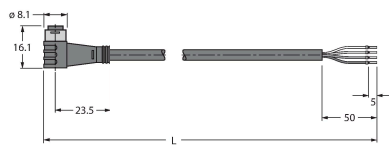

PKW4S-2/TEL

6627373

Connection cable, Ø 8-mm female connector, snap-on, angled, 4-pin, cable length: 2 m, jacket material: PVC, black; cULus approval

Accessories

Dimension drawing	Type	ID	
-------------------	------	----	--

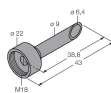

UWG18-6.4

3076952

Ultrasonic focussing-adapter for QS18U and S18U, internal diameter 6.4 mm

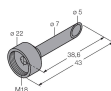

UWG18-5.0

3077342

Ultrasonic focussing-adapter for QS18U and S18U, internal diameter 5.0 mm