

# M18TUP8

## Temperature sensor – Infrared sensor

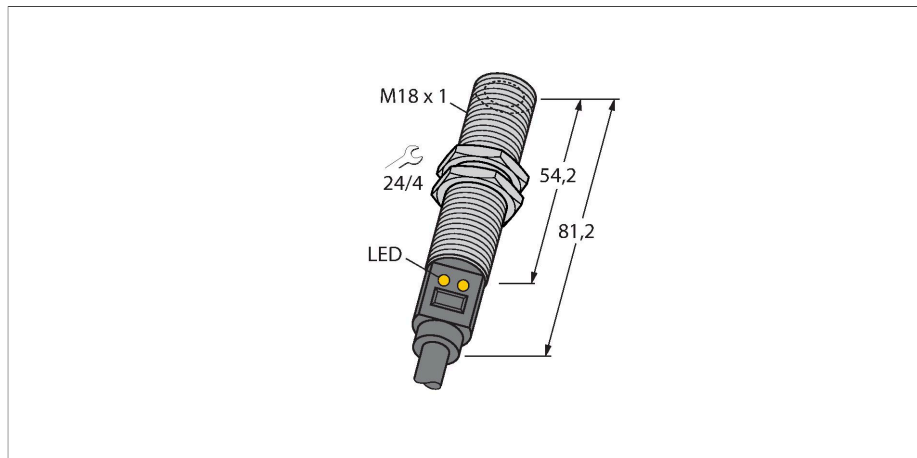

### Features

- Connection via cable, 2 m
- D:S ratio 8:1
- Operating voltage 12...30 VDC
- Measuring range adjustable via teach-in
- Analog output 0...10 V
- PNP Alarm output switches at 10 V
- Temperature range 0 ... +300 °C

### Wiring diagram

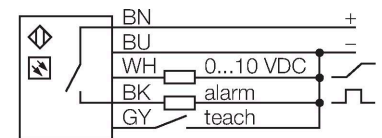

### Technical data

Type	M18TUP8
ID no.	3074915
Measuring range	0...300 °C
Temperature operating range	-4...158 °F
Factory setting	-20...280 °C
	-4...536 °F
Response time	75 ms
Operating voltage	12...30 VDC
Short-circuit/reverse polarity protection	yes / Cyclic / yes
Protection type and class	IP67
Output 1	Analog output
Output 2	switching output
Output function	NO contact, PNP/Analog output
Voltage output	0...10 V
Response time typical	< 75 ms
Ambient temperature	-20...+70 °C
Storage temperature	-20...+70 °C
<b>Housing</b>	
Housing material	Stainless steel, 1.4301 (AISI 304), Grey
Process connection	M18 × 1
Electrical connection	Cable
Cable quality	Ø 6 mm, Black, PVC, 2 m, 2 m
Core cross-section	5 x 0.5 mm <sup>2</sup>
Switching state	LED, Yellow
Included in delivery	2 M18 × 1 metal hexagon nuts

### Functional principle

Temperature sensors are used in applications where temperatures for control and optimisation of processes must be captured and monitored. The sensor operates only as a receiver. The thermal radiation of an object within a wave length range of 8 to 14 µm is transformed into an electrical signal via a thermopile and then further processed to become an output signal. Here the D:S (distance: spot) ratio is very important because it specifies the diameter of the spot at a defined distance. The sensor is optimally aligned, if the spot is completely covered by the object, whose temperature is to be monitored.

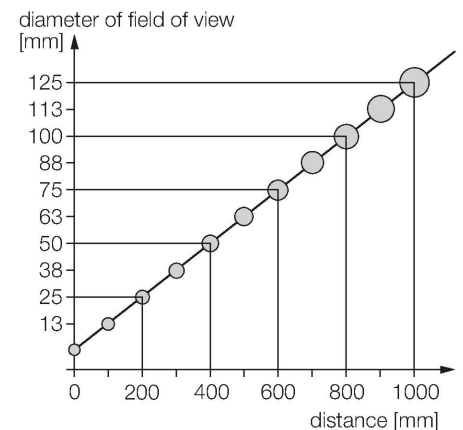

## Accessories

SMB18A

3033200

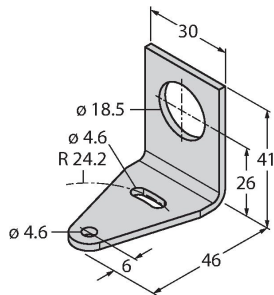

Mounting bracket, rectangular, stainless steel, for sensors with 18 mm thread

SMB18SF

3052519

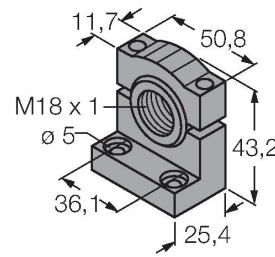

Mounting bracket, PBT black, for sensors with 18 mm thread, rotatable

SMB18UR

3052517

Mounting bracket, for wall mounting, stainless steel 300, 2-piece, rotatable, 18 mm bore hole, screw set included

LAT1812

3074262

Laser alignment aid, visible red, contains M12 laser emitter (laser class 2) and mounting bracket SMB1812, for sensors with 18 mm thread, 10 ... 30 VDC supply necessary