

EA5E150Q

Measuring Light Screen – Emitter

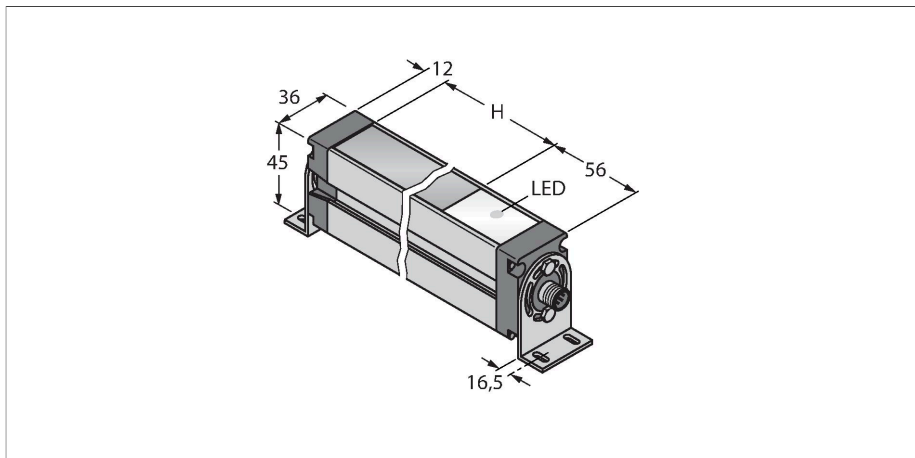

Technical data

Type	EA5E150Q
ID	3075423
Optical data	
Function	Light screen
Operating mode	Emitter
Light type	IR
Optical resolution	5 mm
Range	400...4000 mm
Scan field	150 mm
Number of beams	30
Electrical data	
Operating voltage	12...30 VDC
No-load current	≤ 400 mA
Readiness delay	≤ 2 s
Blanking function	yes
Mechanical data	
Design	Rectangular, EZ-Array
Dimensions	45.2 x 36 x 227 mm
Housing material	Metal, AL, Anodized
Lens	plastic, Acrylic
Electrical connection	Connector, M12 × 1
Ambient temperature	-40...+70 °C
Protection class	IP65
Power-on indication	LED, Red
Error indication	Flashing
Tests/approvals	
Approvals	CE

Features

- Male M12 × 1, 8-pin
- Scan field 150 mm
- Protection class IP65
- Resolution 5 mm
- Max. range 4 m
- 2 × EZA-MBK-11 brackets included in delivery
- Operating voltage 12...30 VDC

Wiring diagram

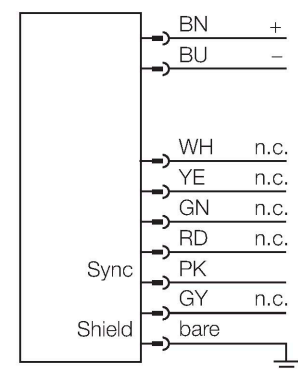

Functional principle

The measuring light screen EZ-Array is ideal for sizing and product profiling, edge and centre guiding, sag and hole detection as well as parts counting. The two-part light screen is easily installed. The electronics is incorporated in the receiver housing and can be configured via 6 DIP switches. For special functions, the screen can be adjusted via PC with the enclosed software. To synchronize emitter and receiver just interconnect the sync-outputs of both.

Accessories

EZA-MBK-11 **3071470**

Mounting bracket, steel, black-finished, for EZ-ARRAY and EZ-SCREEN standard and cascade 14 & 30 mm

EZA-MBK-12 **3071756**

Mounting bracket, steel, black-finished, for EZ-ARRAY and EZ-SCREEN standard and cascade 14 & 30 mm

EZA-MBK-20 **3072587**

Mounting bracket, steel, black-finished, for EZ-ARRAY and EZ-SCREEN standard 14 & 30 mm

Accessories

Dimension drawing	Type	ID	
	RKS8T-2/TEL	6625446	Connection cable, M12 female connector, straight, 8-pin, cable length: 2 m, sheath material: PVC, black; shielded; cULus approval; other cable lengths and qualities available, see www.turck.com
	WKS8T-2/TXL	6625461	Connection cable, M12 female connector, angled, 8-pin shielded, cable length: 2 m, jacket material: PUR, black; cULus approval; other cable lengths and qualities available, see www.turck.com
	RKC8T-2/TEL	6625130	Connection cable, M12 female, straight, 8-pin, cable length: 2 m, jacket material: PVC, black; cULus approval; other cable lengths and qualities available, see www.turck.com
	WKC8T-2/TEL	6625133	Connection cable, M12 female connector, angled, 8-pin, cable length: 2 m, jacket material: PVC, black; cULus approval; other cable lengths and qualities available, see www.turck.com

Dimension drawing

Type

WKS8T-2/TEL

ID

6625449

Connection cable, M12 female connector, angled, 8-pin, cable length: 2 m, sheath material: PVC, black; shielded; cULus approval; other cable lengths and qualities available, see www.turck.com

