

EA5R450PIXMODQ

Measuring Light Screen – Receiver

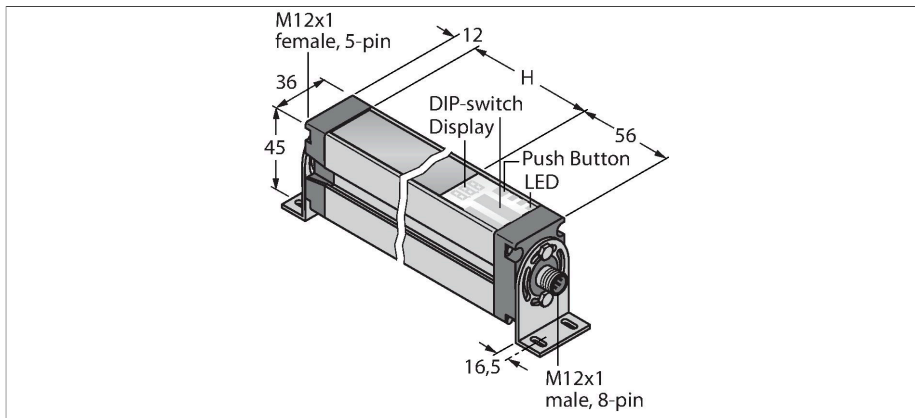

Technical data

Type	EA5R450PIXMODQ
ID	3077529
Optical data	
Function	Light screen
Operating mode	Receiver
Optical resolution	5 mm
Range	400...4000 mm
Scan field	450 mm
Number of beams	90
Electrical data	
Operating voltage	12...30 VDC
DC rated operational current	≤ 375 mA
No-load current	≤ 400 mA
Communication protocol	Modbus RTU RS485
Output function	2 normally open contact, PNP/Analog output
Type of analog output	4...20 mA
Current output	4...20 mA
Load resistance	≤ 1350 Ω
Readiness delay	≤ 2 s
Response time typical	< 7.1 ms
Blanking function	yes
Mechanical data	
Design	Rectangular, EZ-Array
Dimensions	45.2 x 36 x 529 mm
Housing material	Metal, AL, Anodized
Lens	plastic, Acrylic
Electrical connection	Connector, M12 × 1

Features

- Male M12 × 1, 8-pin
- Scan field 450 mm
- Protection class IP65
- Resolution 5 mm
- Max. range 4 m
- 2 × EZA-MBK-11 brackets included in delivery
- Operating voltage 12...30 VDC
- 2x PNP switching output
- 2x analog output 4...20 mA
- Modbus RTU via RS485, female M12 × 1, 5-pin
- Supports baud rates: 9600, 19200, 38400, 57600 and 115200 Bd

Wiring diagram



Technical data

Ambient temperature	-40...+70 °C
Protection class	IP65
Power-on indication	LED, Red
Error indication	LED, red (dual color LED)
Excess gain indication	LED, red
Tests/approvals	
Approvals	CE

Functional principle

The measuring light screen EZ-Array is ideal for sizing and product profiling, edge and centre guiding, sag and hole detection as well as parts counting. The two-part light screen is easily installed. The electronics is incorporated in the receiver housing and can be configured via 6 DIP switches. For special functions, the screen can be adjusted via PC with the enclosed software. To synchronize emitter and receiver just interconnect the sync-outputs of both.

Accessories

EZA-MBK-11 3071470

Mounting bracket, steel, black-finished, for EZ-ARRAY and EZ-SCREEN standard and cascade 14 & 30 mm

EZA-MBK-12 3071756

Mounting bracket, steel, black-finished, for EZ-ARRAY and EZ-SCREEN standard and cascade 14 & 30 mm

EZA-MBK-20 3072587

Mounting bracket, steel, black-finished, for EZ-ARRAY and EZ-SCREEN standard 14 & 30 mm

Accessories

Dimension drawing	Type	ID	
	RKC8T-2/TEL	6625130	Connection cable, M12 female, straight, 8-pin, cable length: 2 m, jacket material: PVC, black; cULus approval; other cable lengths and qualities available, see www.turck.com
	WKC8T-2/TEL	6625133	Connection cable, M12 female connector, angled, 8-pin, cable length: 2 m, jacket material: PVC, black; cULus approval; other cable lengths and qualities available, see www.turck.com
	EZA-USB-485-01	3083025	USB-RS485 converter cable, male M12 x 1 on male USB type A

Dimension drawing	Type	ID	
	RKS8T-2/TEL	6625446	Connection cable, M12 female connector, straight, 8-pin, cable length: 2 m, sheath material: PVC, black; shielded; cULus approval; other cable lengths and qualities available, see www.turck.com
	WKS8T-2/TEL	6625449	Connection cable, M12 female connector, angled, 8-pin, cable length: 2 m, sheath material: PVC, black; shielded; cULus approval; other cable lengths and qualities available, see www.turck.com
	RSS4.5T-2/TEL	6626367	
	RKS4.5T-2-RSS4.5T/TEL	6626388	