

QS18EN6FPQPMA

Photoelectric Sensor – Photoelectric Sensor for Plastic Fibers

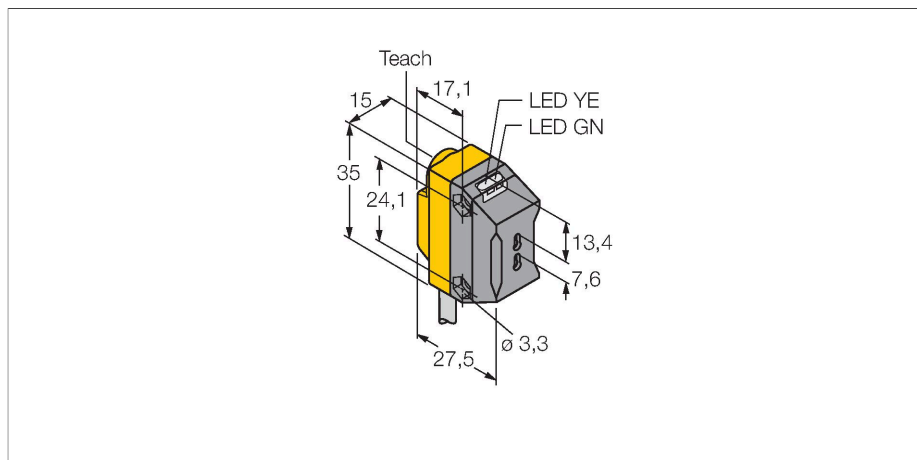

Technical data

Type	QS18EN6FPQPMA
ID	3078014
Optical data	
Function	Fiber optic sensor
Operating mode	Plastic fiber
Fiber-optic type	Plastic
Light type	Red
Wavelength	660 nm
Electrical data	
Operating voltage	10...30 VDC
DC rated operational current	≤ 100 mA
No-load current	≤ 35 mA
Reverse polarity protection	yes
Output function	NO contact, NPN
Switching frequency	≤ 833 Hz
Readiness delay	≤ 100 ms
Response time typical	< 0.6 ms
Setting option	Push Button Remote Teach
Mechanical data	
Design	Rectangular, QS18
Dimensions	27.5 x 15 x 35 mm
Housing material	Plastic, Thermoplastic material
Electrical connection	Cable with connector, M12 × 1, 0.15 m, PUR
Number of cores	4
Ambient temperature	-20...+70 °C
Relative humidity	0...95 %

Features

- Cable with male end M12 × 1, 4-pin, PUR, 150 mm
- Protection class IP67
- LED all-round visible
- Sensitivity adjusted via teach button
- Operating voltage: 10...30 VDC
- NPN switching output
- Light or dark operation

Wiring diagram

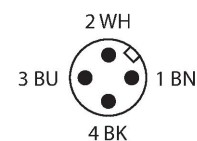
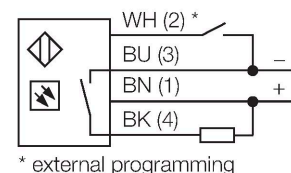

Functional principle

Glass or fibre optic sensors are the optimum choice for high temperature or space restricted applications. Fibre optics transfer the light from the sensor to a remote object. Individual fiber-optics are used for opposed mode sensing, whereas bifurcated fiber-optics are suited for diffuse mode operation.

Excess gain curve
Excess gain depending on range of opposed mode sensors (type F with fiber-optics IT23S and type FP with fiber-optics PIT46U)

Technical data

Protection class	IP67
Special features	keep/defer Wash down
Power-on indication	LED, Green
Switching state	LED, Yellow
Error indication	LED, green, Flashing
Excess gain indication	LED
Alarm display	LED yellow Flashing
Tests/approvals	
Approvals	CE, cURus

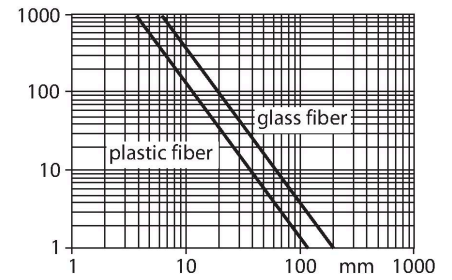

Accessories

SMB18A

3033200

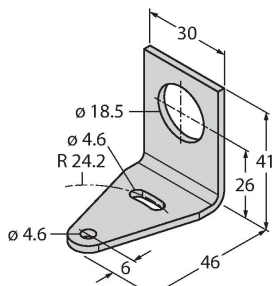

Mounting bracket, rectangular, stainless steel, for sensors with 18 mm thread

SMBQS18A

3069721

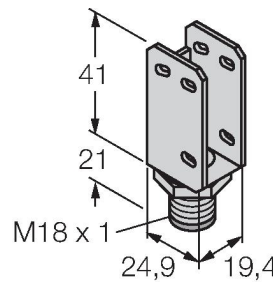

Mounting bracket, stainless steel, for 18 mm thread

SMBQS18AF

3067467

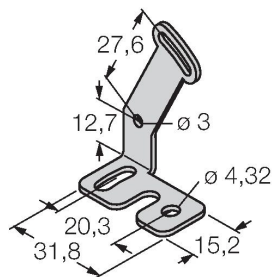

Mounting bracket, stainless steel, for 18 mm thread

Accessories

Dimension drawing	Type	ID	
	PBT46U	3025967	Plastic fiber-optic sensor, operating mode: Diffuse mode, threaded sleeve M3 x 0.75 mm, field wireable wire without end tip, polyethylene sheath, ambient temperatures -30 °C...+70 °C

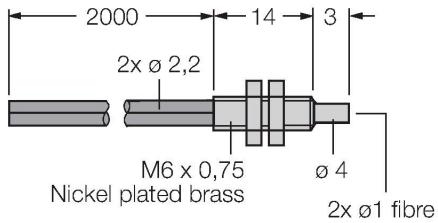

	PIT46U	3026034	Plastic fiber-optic sensor, operating mode: Opposed mode, threaded sleeve M3 x 0.5 mm, field wireable wire without end tip, polyethylene sheath, ambient temperatures -30 °C...+70 °C
--	--------	---------	---

