

Q20NDXL

Photoelectric Sensor – Diffuse Mode Sensor

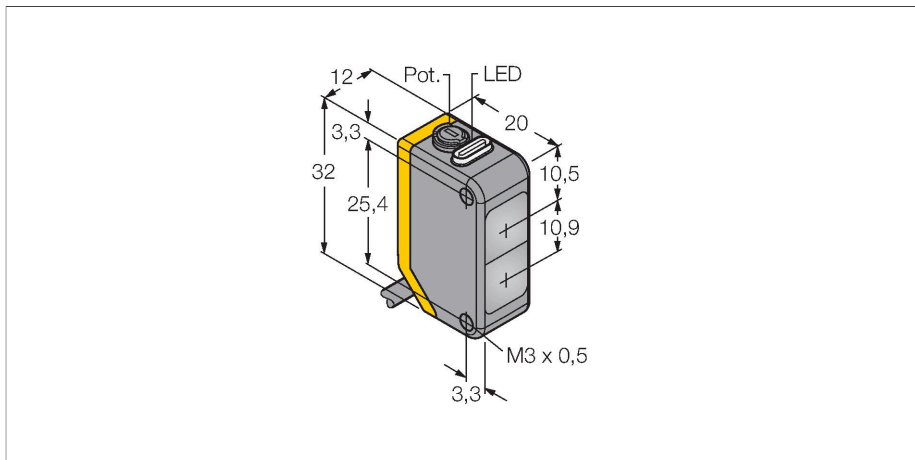

Technical data

Type	Q20NDXL
ID	3078153
Optical data	
Function	Proximity switch
Operating mode	Diffuse
Light type	IR
Wavelength	850 nm
Range	1...1500 mm
Electrical data	
Operating voltage	10...30 VDC
Residual ripple	< 10 % U _{ss}
DC rated operational current	≤ 100 mA
No-load current	≤ 18 mA
Reverse polarity protection	yes
Output function	Complementary contact, NPN
Switching frequency	≤ 600 Hz
Readiness delay	≤ 100 ms
Response time typical	< 0.8 ms
Setting option	Potentiometer
Mechanical data	
Design	Rectangular, Q20
Dimensions	20 x 12 x 32 mm
Housing material	Plastic, Thermoplastic material
Lens	plastic, Acrylic
Electrical connection	Cable, 2 m, PVC
Number of cores	4
Core cross-section	0.35 mm ²

Features

- Cable, PVC, 2 m
- Protection class IP67
- LED all-round visible
- Sensitivity adjusted via potentiometer
- Operating voltage: 10...30 VDC
- NPN switching output, changeover

Wiring diagram

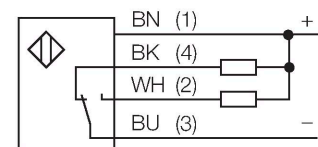

Functional principle

Identical to retro-reflective sensors, emitter and receiver circuitry are incorporated in the same housing of the diffuse mode sensors. However, diffuse mode sensors do not detect the interruption of the light beam but the reflection of the target. A target is detected if it reflects a sufficient amount of light back to the receiver. The sensing range of diffuse mode sensors thus largely depends on the reflectivity of the target.

Excess gain curvee
Excess gain in relation to the distance

Technical data

Ambient temperature	-20...+60 °C
Protection class	IP67
Power-on indication	LED, Green
Switching state	LED, Yellow
Error indication	LED, green, Flashing
Excess gain indication	LED, yellow, flashing
Tests/approvals	
Approvals	CE

Excess Gain Curve

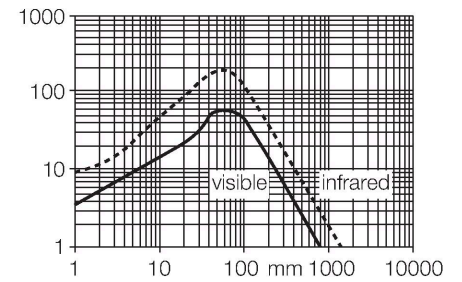

Accessories

SMBQ20H 3079041

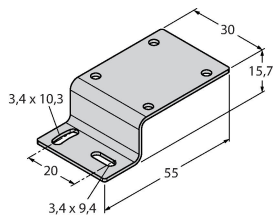

Mounting bracket, stainless steel, horizontally mounted, for Q20

SMBQ20L 3079040

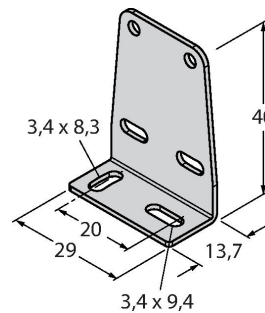

Mounting bracket, stainless steel, rectangular, for Q20

SMBQ20LV 3079042

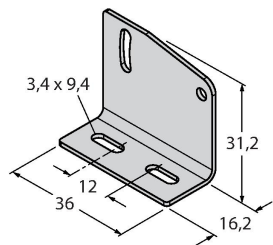

Mounting bracket, stainless steel, rectangular, for Q20

SMBQ20U 3079043

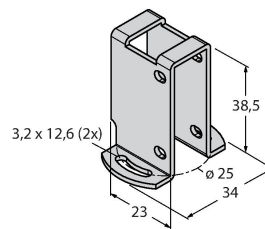

Protective housing, stainless steel, for Q20