

Q20ELQ7

Photoelectric Sensor – Opposed Mode Sensor (Emitter)

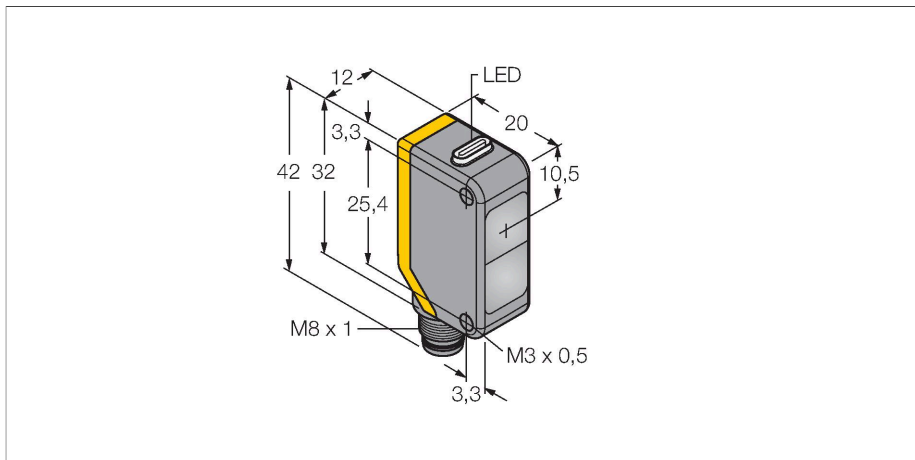

Technical data

Type	Q20ELQ7
ID	3078160
Optical data	
Function	Opposed mode sensor
Operating mode	Emitter
Light type	IR
Wavelength	850 nm
Range	0...20000 mm
Electrical data	
Operating voltage	10...30 VDC
Residual ripple	< 10 % U _{ss}
No-load current	≤ 18 mA
Reverse polarity protection	yes
Readiness delay	≤ 100 ms
Mechanical data	
Design	Rectangular, Q20
Dimensions	20 x 12 x 42 mm
Housing material	Plastic, Thermoplastic material
Lens	plastic, Acrylic
Electrical connection	Connector, M8 × 1, PVC
Number of cores	4
Ambient temperature	-20...+60 °C
Protection class	IP67
Power-on indication	LED, Green
Excess gain indication	LED
Tests/approvals	
Approvals	CE

Features

- Male M8 × 1; 4-pin
- Protection class IP67
- LED all-round visible
- Operating voltage: 10...30 VDC

Wiring diagram

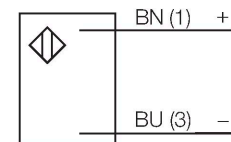

Functional principle

Opposed mode sensors consist of an emitter and receiver. They are installed opposite each other so that the light from the emitter is aimed directly at the receiver. When an object interrupts or weakens the light beam, the sensor switches. Opposed mode sensors are the most reliable photoelectric sensors for detection of opaque targets. An excellent contrast between light and dark conditions and an extremely high excess gain are typical of this sensing mode, thus allowing operation over larger distances and under difficult conditions.

Excess Gain Curve

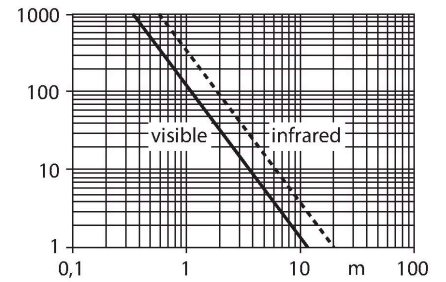

Accessories

SMBQ20H

3079041

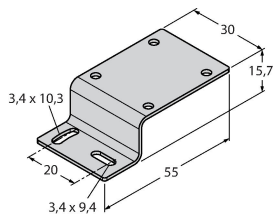

Mounting bracket, stainless steel, horizontally mounted, for Q20

SMBQ20L

3079040

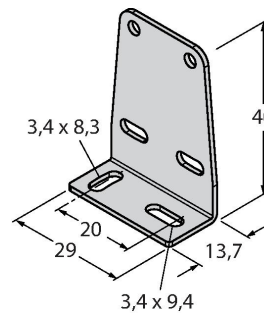

Mounting bracket, stainless steel, rectangular, for Q20

SMBQ20LV

3079042

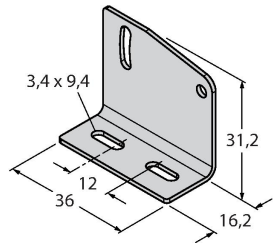

Mounting bracket, stainless steel, rectangular, for Q20

SMBQ20U

3079043

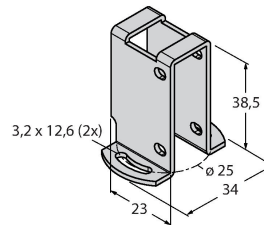

Protective housing, stainless steel, for Q20

Accessories

Dimension drawing

Type

ID



PKW4M-2/TEL

6625067

Connection cable, female M8, angled, 4-pin, cable length: 2 m, sheath material: PVC, black; cULus approval; other cable lengths and qualities available, see www.turck.com



PKG4M-2/TEL

6625061

Connection cable, female M8, straight, 4-pin, cable length: 2 m, sheath material: PVC, black; cULus approval; other cable lengths and qualities available, see www.turck.com