

M12PLPQ5

Photoelectric Sensor – Retroreflective Sensor with Polarizing Filter

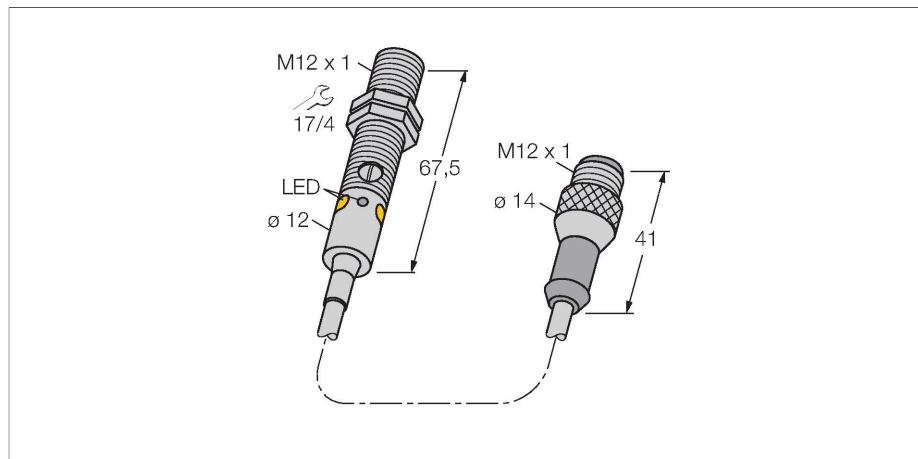

Features

- Cable with male end M12 × 1, 4-pin, PVC, 150 mm
- Protection classes IP67 / IP68
- Metal housing
- LED all-round visible
- Indication of insufficient excess gain
- Sensitivity adjustable via potentiometer
- Operating voltage: 10...30 VDC
- PNP switching output, complementary contact

Wiring diagram

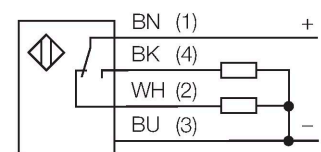

Technical data

Type	M12PLPQ5
ID	3078238
Optical data	
Function	Retroreflective Sensor
Operating mode	Polarized
Reflector included in delivery	no
Light type	Red polarized
Wavelength	660 nm
Range	20...1500 mm
Electrical data	
Operating voltage	10...30 VDC
Residual ripple	< 10 % U _{ss}
DC rated operational current	≤ 100 mA
No-load current	≤ 20 mA
Short-circuit protection	yes
Reverse polarity protection	yes
Output function	Complementary contact, PNP
Switching frequency	≤ 1000 Hz
Readiness delay	≤ 100 ms
Response time typical	< 0.5 ms
Setting option	Potentiometer
Mechanical data	
Design	Tube, M12
Dimensions	Ø 12 x 67.5 mm
Housing material	Metal, Nickel-plated brass, Nickel Plated
Lens	plastic, PMMA

Functional principle

Retro-reflective sensors incorporate emitter and receiver in a single compact housing. The light beam of the emitter is directed towards a reflector which returns the light back to the receiver. An object is detected when it interrupts this beam. Retro-reflective sensors incorporate some of the advantages of opposed mode sensors (good contrast and high excess gain). Further it is merely required to install and wire a single device. A smaller sensing range and susceptibility of devices without polarisation filter can be of disadvantage when shiny objects have to be detected.

Excess Gain Curve

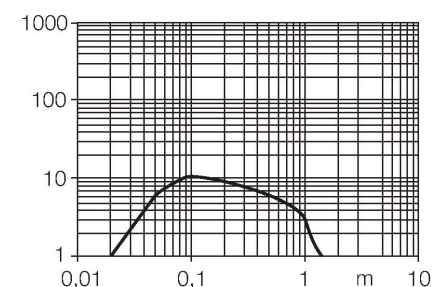

Technical data

Electrical connection	Cable with connector, M12 × 1, 0.15 m, PVC
Number of cores	4
Ambient temperature	-20...+60 °C
Protection class	IP67 IP68
Special features	Encapsulated Wash down
Power-on indication	LED, Green
Switching state	LED, Yellow
Error indication	LED, green, Flashing
Excess gain indication	LED, yellow, flashing
Tests/approvals	
MTTF	46 years acc. to SN 29500 (Ed. 99) 40 °C
Approvals	CE

Accessories

SMB12FAM10

3011221

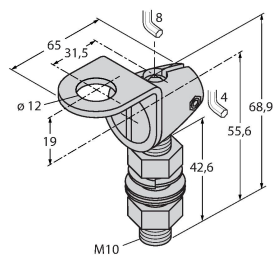

Mounting bracket, stainless steel, for M12, M10 x 1.5 thread

SMB12MM

3027635

Mounting bracket, stainless steel, for M12

SMBQS12PD

3059606

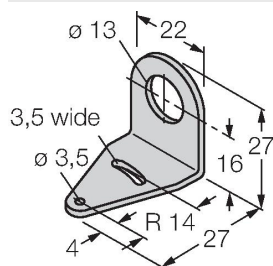

Mounting bracket; material VA 1.4401, for Q12 & M12 series

Accessories

Dimension drawing

Type

ID

RKC4.4T-2/TEL

6625013

Connection cable, female M12, straight, 4-pin, cable length: 2 m, sheath material: PVC, black; cULus approval; other cable lengths and qualities available, see www.turck.com

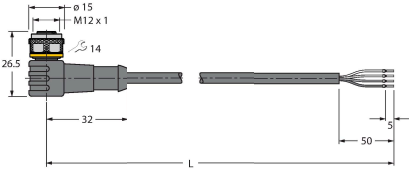

Dimension drawing	Type	ID	
	WKC4.4T-2/TEL	6625025	Connection cable, female M12, angled, 4-pin, cable length: 2 m, sheath material: PVC, black; cULus approval; other cable lengths and qualities available, see www.turck.com

Accessories

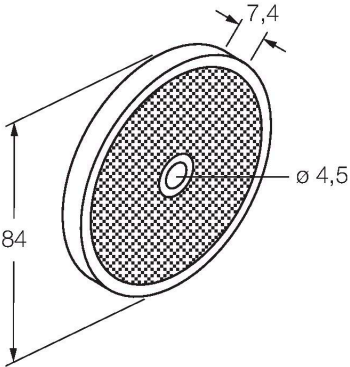
Dimension drawing	Type	ID	
	BRT-84	3058979	Round reflector, reflection coefficient 1.4, material acrylic, ambient temperature -20 ... +60 °C