

# K50FLGRYB4PQ

## LED Indicator – Beacon

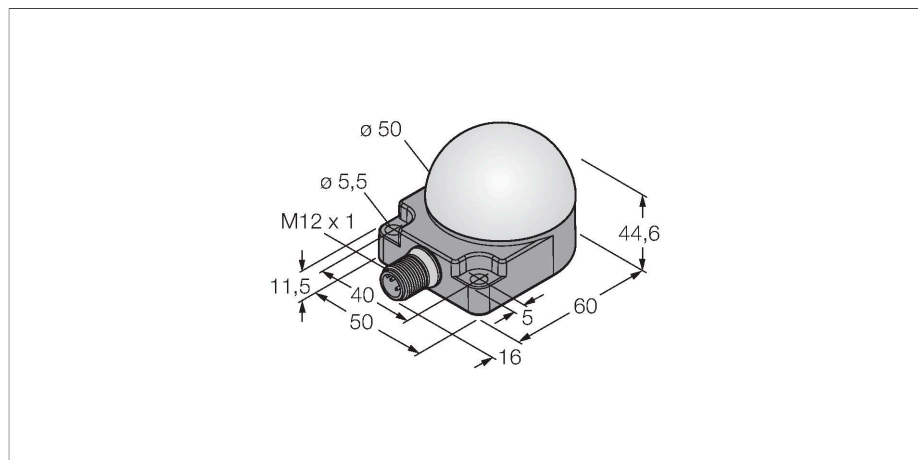

### Features

- LED all-round visible
- Flat mounting
- Individually controllable
- Protection classes IP67/IP69K
- Multicolor: Green (COL 1) / Red (COL 2) / Yellow (COL 3) / Blue (COL 4)
- M12 × 1 male, 5-pin
- Operating voltage 18...30 VDC

### Wiring diagram

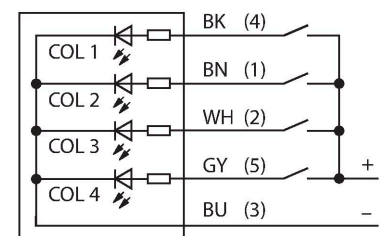

### Functional principle

The LED display is suitable for industrial use thanks to its rugged design in protection class IP67. Depending on the pin assignment, one of the three colors lights either steady or flashes during the period of one PNP input signal. The "2" in the type code indicates the flashing function of the LED. For example: when connecting the brown and the black wire to 24 VDC, the LED starts flashing red. You find a more detailed description of the terminal programming in the instruction leaflet delivered with the item. Alternate flashing of all colors is also possible. The wiring diagram shows the PNP input configuration. An instruction leaflet with detailed information about the connection is included with the devices.

### Technical data

Type	K50FLGRYB4PQ
ID	3083447
<b>Signal and display data</b>	
Purpose	LED indicator light
Function	Spotlight
Light type	Green Red Yellow Blue
Dimmable	No
Features of color 1	Green, Miscellaneous
Features of color 2	Red
Features of color 3	Yellow
Features of color 4	Blue
Special features	Wash down
<b>Electrical data</b>	
Operating voltage	18...30 VDC
DC rated operational current	≤ 50 mA
Max. current consumption per color	50 mA
Input type	PNP
Response time typical	< 250 ms
<b>Mechanical data</b>	
Cascadable	No
Design	Dome, K50F
Dimensions	50 x 76 x 44.6 mm
Housing material	Plastic, PC, Black
Window material	Polycarbonate, diffuse
Electrical connection	Connector, M12 × 1, PVC



## Technical data

Number of cores	5
Ambient temperature	-40...+50 °C
Relative humidity	0...95 %
Protection class	IP67 IP69
<b>Tests/approvals</b>	
Approvals	CE

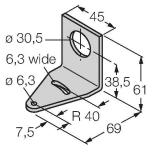
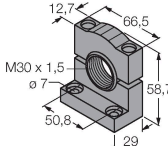
## Accessories

<b>SMB30A</b>	<b>3032723</b>	<b>SMB30SC</b>	<b>3052521</b>
 <p>Mounting bracket, rectangular, stainless steel, for sensors with 30mm thread</p>		 <p>Mounting bracket, PBT black, for sensors with 30 mm thread, rotatable</p>	

## Accessories

Dimension drawing	Type	ID	
	RKC4.5T-2/TEL	6625016	Connection cable, M12 female connector, straight, 5-pin, cable length: 2 m, jacket material: PVC, black; cULus approval
	WKC4.5T-2/TEL	6625028	Connection cable, M12 female connector, angled, 5-pin, cable length: 2 m, jacket material: PVC, black; cULus approval
	RKC4.4T-2/TEL	6625013	Connection cable, M12 female connector, straight, 4-pin, cable length: 2 m, jacket material: PVC, black; cULus approval

## Dimension drawing

## Type

WKC4.4T-2/TEL

## ID

6625025

Connection cable, M12 female connector, angled, 4-pin, cable length: 2 m, jacket material: PVC, black; cULus approval

