

# IVU2PRBR06

## Identification – Barcode Reader — Image Sensor

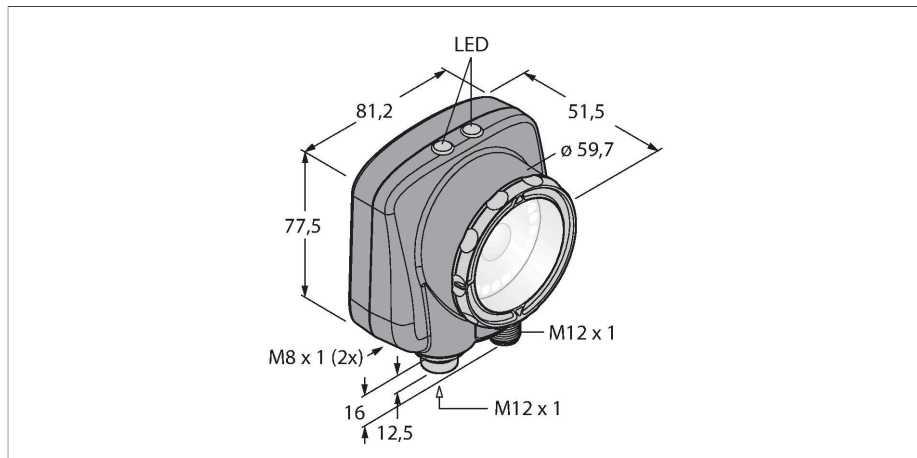

### Technical data

Type	IVU2PRBR06
ID	3090728
<b>Camera data</b>	
Function	Barcode reader — image sensor
Resolution	752 x 480 Pixels
Light type	Red
Brennweite	6 mm
Special features	Wash down
<b>Electrical data</b>	
Operating voltage	10...30 VDC
DC rated operational current	≤ 1000 mA
Communication protocol	EtherNet/IP Modbus TCP PCCC PROFINET RS232
<b>Mechanical data</b>	
Design	Rectangular, iVu PLUS
Dimensions	51.5 x 81.2 x 95.3 mm
Housing material	Plastic, Thermoplastic material, Black
Window material	Acrylic, clear
Electrical connection	Connector, M12 × 1, 12-wire
Display	Remote
Ambient temperature	0...+50 °C
Protection class	IP67
<b>Tests/approvals</b>	
Approvals	CE

### Features

- Second iVu generation
- Internal memory for 30 inspections
- 1/3" CMOS, 752x480 pixels
- Integrated ring light: Red
- Protection class IP67
- External strobe output + 5 VDC
- External trigger input
- Lens, 6mm, M12x1
- External display RDM35 required
- Operating voltage 10...30 VDC
- M12 × 1 male, 12-pin
- 3 x programmable switching output (PNP/ NPN)
- 1 x RS232 data communication
- Ethernet via M8 x 1 male, 4-pin
- USB 2.0 host: M8 female, 4-pin
- Industrial Ethernet: PROFINET, Ether-Net/IP, Modbus/TCP, PCCC

### Wiring diagram

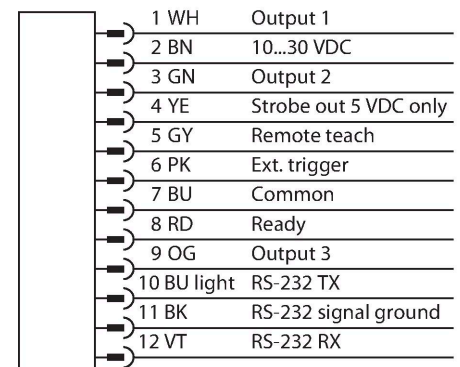

### Functional principle

The second generation of the iVu-Plus offers the user advanced features and even more options in the selection of the inspections. The sensor is equipped with the same housing and

offers the same intuitive user interface and functionality of the previous iVu generation. The barcode reader consists of a camera and an integrated light (except the IVU2RBX version) able to scan up to 10 different barcodes and to transmit the data via the RS232 interface. A selection can be configured for certain barcode types such as DataMatrix (ECC 200) and a number of linear codes such as Code128, Code39, CODABAR, Interleaved 2 of 5, EAN13, EAN8, UPCE, Postnet, IMB and Pharmacode. The possibility to select between coarse and fine resolution is available with the new generation. Sensor configuration via PC is not required! Log files and firmware updates can be transmitted via the USB interface.

## Mounting instructions

### Mounting instructions/Description

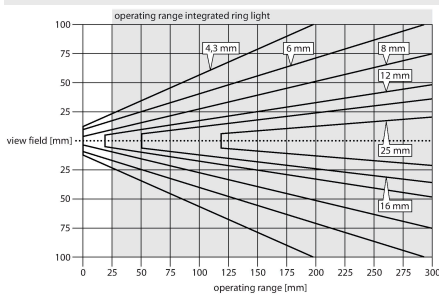

**Selecting the focal length**  
With known object size or scan field the matching vision sensor is found simply by determining the ratio between the sensing range and the focal length. Use the graphics for selection. Here, the sensing ranges are put in relation to the field view and the lens focal length.

## Accessories

### SMBIVURAR 3082547

Brackets for mounting on right side

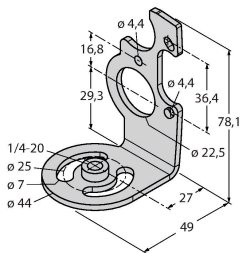

### SMBIVURAL 3082546

Brackets for mounting on left side

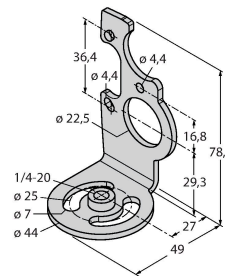

### SMBIVUU 3082549

U-bracket for base mounting (incl. SMBIVUB baseplate)

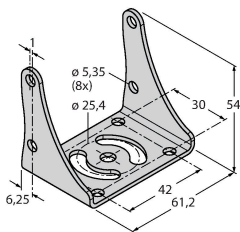

Accessories

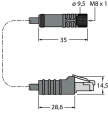
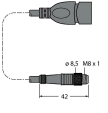
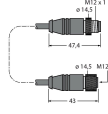
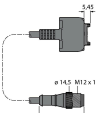
Dimension drawing	Type	ID	
	IVUC-1206	3014407	Power supply, M12 × 1 female connector, 12-pin, cable length: 1.83 m
	IVUC-E-406	3013892	Ethernet connection cable, M8 × 1 on RJ45, 4-pin, cable length: 2 m
	PSG-4M-401-USB	3011336	USB adapter cable, M8 × 1 male connector, 4-pin, cable length: 0.3 m
	IVURDM-QD-803	3028673	Extension cable for RDM35 remote display, M12 × 1, 8-pin, cable length: 0.91 m
	IVURD-MX-803	3011330	Extension cable for RD35 remote display, M12 × 1 to Molex, 8-pin, cable length: 0.91 m

Accessories

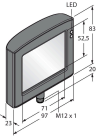
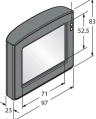
Dimension drawing	Type	ID	
	RDM35	3029512	Remote display 3.5" touch screen for device installation, connection via M12 plug connector, IVURDM-QD-8.. or IVURDM-QDK-8.. required
	RD35	3082646	Remote display 3.5", touch screen, connection via Molex integral connector, IVURD-MX-8.. or IVURD-MXK-8.. required