

# IVU2PRBW04

## Identification – Barcode Reader — Image Sensor

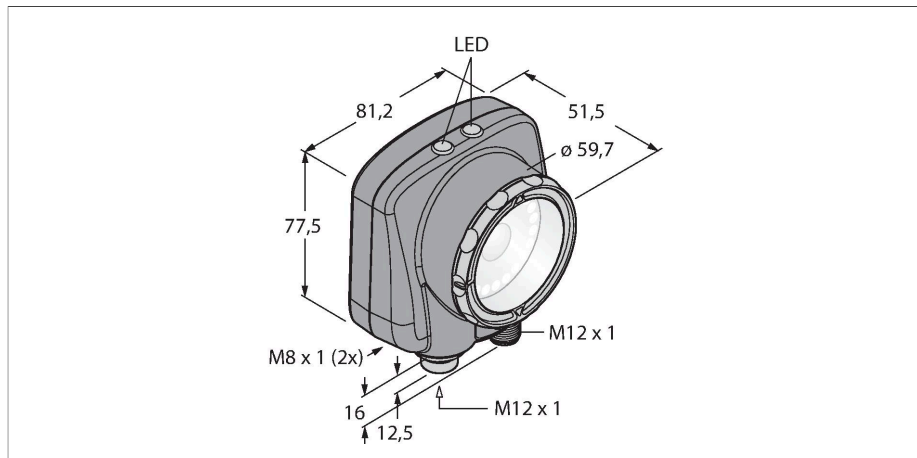

### Technical data

|                              |  |
|------------------------------|--|
| Type                         | IVU2PRBW04   |
| ID                           | 3090959  |
| <b>Camera data</b>           |  |
| Function                     | Barcode reader — image sensor                          |
| Resolution                   | 752 x 480 Pixels                                       |
| Light type                   | White  |
| Brennweite                   | 25 mm  |
| Special features             | Wash down  |
| <b>Electrical data</b>       |  |
| Operating voltage            | 10...30 VDC  |
| DC rated operational current | ≤ 1000 mA  |
| Communication protocol       | EtherNet/IP<br>Modbus TCP<br>PCCC<br>PROFINET<br>RS232 |
| <b>Mechanical data</b>       |  |
| Design                       | Rectangular, iVu PLUS                                  |
| Dimensions                   | 51.5 x 81.2 x 95.3 mm                                  |
| Housing material             | Plastic, Thermoplastic material, Black                 |
| Window material              | Acrylic, clear   |
| Electrical connection        | Connector, M12 × 1, 12-wire                            |
| Display                      | Remote   |
| Ambient temperature          | 0...+50 °C   |
| Protection class             | IP67   |
| <b>Tests/approvals</b>       |  |
| Approvals                    | CE   |

### Features

- Second iVu generation
- Internal memory for 30 inspections
- 1/3" CMOS, 752x480 pixels
- Integrated ring light: White
- Protection class IP67
- External strobe output + 5 VDC
- External trigger input
- Lens, 4.3mm, M12x1
- External display RDM35 required
- Operating voltage 10...30 VDC
- M12 × 1 male, 12-pin
- 3 x programmable switching output (PNP/ NPN)
- 1 x RS232 data communication
- Ethernet via M8 x 1 male, 4-pin
- USB 2.0 host: M8 female, 4-pin
- Industrial Ethernet: PROFINET, Ether-Net/IP, Modbus/TCP, PCCC

### Wiring diagram

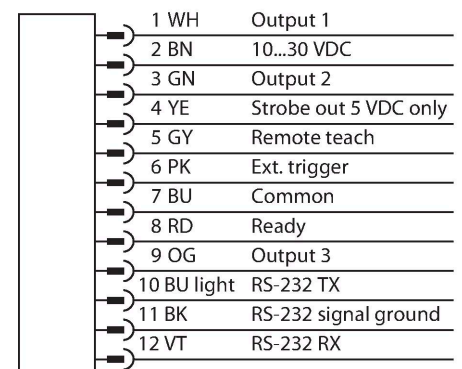

### Functional principle

The second generation of the iVu-Plus offers the user advanced features and even more options in the selection of the inspections. The sensor is equipped with the same housing and

offers the same intuitive user interface and functionality of the previous iVu generation. The barcode reader consists of a camera and an integrated light (except the IVU2RBX version) able to scan up to 10 different barcodes and to transmit the data via the RS232 interface. A selection can be configured for certain barcode types such as DataMatrix (ECC 200) and a number of linear codes such as Code128, Code39, CODABAR, Interleaved 2 of 5, EAN13, EAN8, UPCE, Postnet, IMB and Pharmacode. The possibility to select between coarse and fine resolution is available with the new generation. Sensor configuration via PC is not required! Log files and firmware updates can be transmitted via the USB interface.

## Mounting instructions

### Mounting instructions/Description

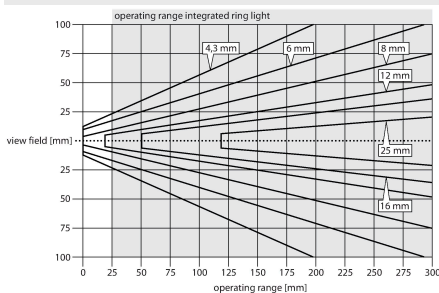

**Selecting the focal length**  
With known object size or scan field the matching vision sensor is found simply by determining the ratio between the sensing range and the focal length. Use the graphics for selection. Here, the sensing ranges are put in relation to the field view and the lens focal length.

## Accessories

### SMBIVURAR 3082547

Brackets for mounting on right side

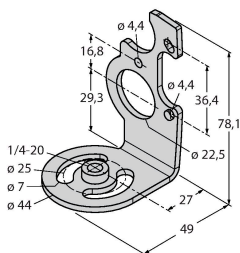

### SMBIVURAL 3082546

Brackets for mounting on left side

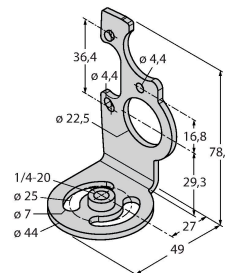

### SMBIVUU 3082549

U-bracket for base mounting (incl. SMBIVUB baseplate)

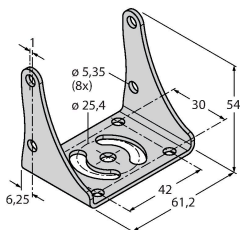

Accessories

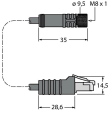
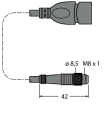
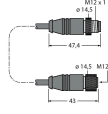
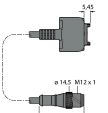
| Dimension drawing  | Type           | ID      |  |
|--|----------------|---------|--|
|   | IVUC-1206      | 3014407 | Power supply, M12 × 1 female connector, 12-pin, cable length: 1.83 m                   |
|   | IVUC-E-406     | 3013892 | Ethernet connection cable, M8 × 1 on RJ45, 4-pin, cable length: 2 m                    |
|   | PSG-4M-401-USB | 3011336 | USB adapter cable, M8 × 1 male connector, 4-pin, cable length: 0.3 m                   |
|   | IVURDM-QD-803  | 3028673 | Extension cable for RDM35 remote display, M12 × 1, 8-pin, cable length: 0.91 m         |
|  | IVURD-MX-803   | 3011330 | Extension cable for RD35 remote display, M12 × 1 to Molex, 8-pin, cable length: 0.91 m |

Accessories

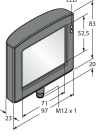
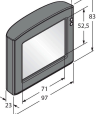
| Dimension drawing   | Type  | ID      |   |
|---|-------|---------|---|
|  | RDM35 | 3029512 | Remote display 3.5" touch screen for device installation, connection via M12 plug connector, IVURDM-QD-8.. or IVURDM-QDK-8.. required |
|  | RD35  | 3082646 | Remote display 3.5", touch screen, connection via Molex integral connector, IVURD-MX-8.. or IVURD-MXK-8.. required                    |